

Maine Department of Transportation

Pavement Condition Report



MaineDOT

OXFORD COUNTY REGIONAL AIRPORT (81B)



**DuBois
& King** inc.



Submitted To:
Maine Department of Transportation
16 State House Station
Augusta, ME 04333



Submitted By:
DuBois & King & ARA
355 Husson Avenue - Suite 1
Bangor, Maine 04401

Executive Summary

Background

To assist individual airports to effectively maintain their pavement infrastructure and help improve airport pavement conditions statewide, the Maine Department of Transportation (MaineDOT) contracted with DuBois & King, Inc. (D&K) to provide pavement evaluation surveys at local airports. Assisting D&K on this effort was Applied Research Associates, Inc. (ARA). This report documents the pavement condition at Oxford County Regional Airport (81B) in November 2018.

A primary objective of the pavement management program is to determine maintenance and rehabilitation needs by comparing pavement condition to a standardized benchmark called the minimum service level (MSL), defined by MaineDOT as the minimum pavement condition desirable in managing Maine airfield pavements. The benchmark MSL values used to trigger rehabilitation are shown below.

Runway	Taxiway	Apron
70	70	70

Pavement Condition

The average inspected Pavement Condition Index (PCI) for all the airfield pavements at 81B was 73. Runway 15-33 had an average inspected PCI of 88, which is above the MSL of 70. Taxiways had an average inspected PCI of 91, and aprons had an average inspected PCI of 55. A comparison of the average PCI values at 81B to the statewide average PCI values, by branch use, is shown in the figure below.

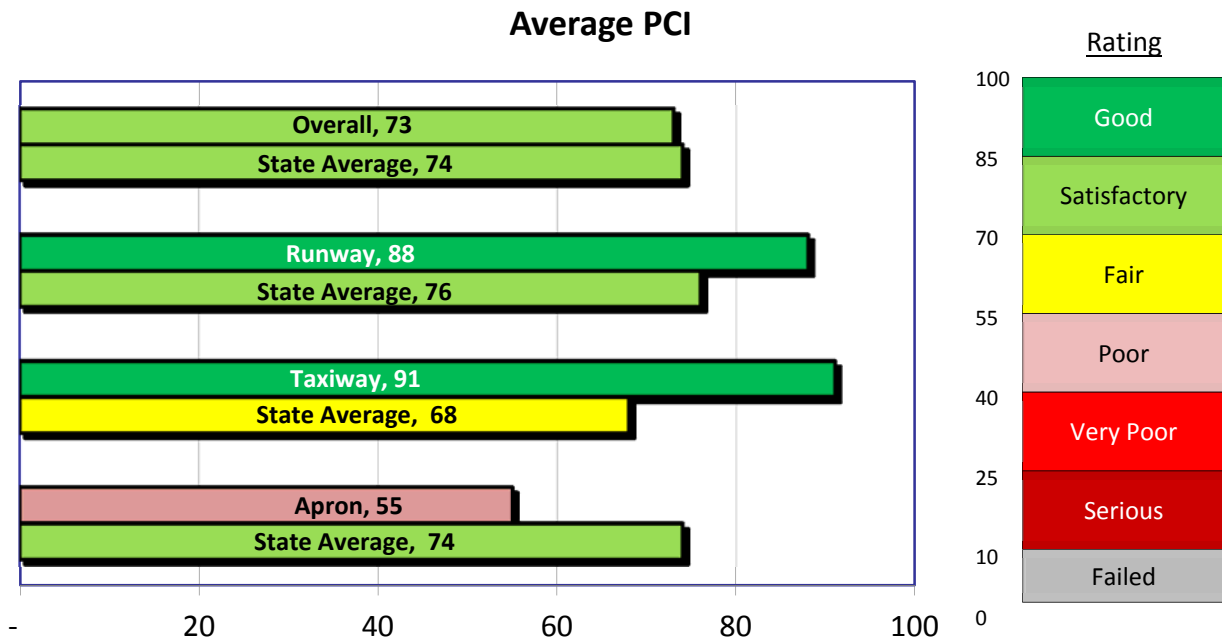

Capital Improvement Program

The table below provides a summary of the projected funds needed to perform major rehabilitation on all pavement sections forecasted to fall below the MSL within the next 5 years. One section, APA-001, was identified for major rehabilitation based on its PCI rating. If no action is taken, the overall PCI is projected to drop from 73 to 65 by 2023.

Project Year	Calendar Year	Amount	PCI Before	PCI After
Year 1	2019	\$0	72	72
Year 2	2020	\$4,545,042	70	92
Year 3	2021	\$0	90	90
Year 4	2022	\$0	89	89
Year 5	2023	\$0	87	87
5-Year Total		\$4,545,042		

Maintenance

Based on the pavement distress documented during the survey, an analysis of potential maintenance projects identified needs of approximately \$42,000. The estimated quantity and cost for each type of maintenance action is shown in the table below. The decision matrix and unit costs upon which these estimates are based are described in section 3 and appendix E of this report.

Ongoing development of capital improvement projects may address some of these maintenance needs. To help budgeting and prevent duplication of effort, all pavement features recommended for maintenance should be compared to planned improvements prior to finalizing a maintenance program strategy.

Specific recommendations to help prioritize airfield maintenance are found in chapter 3 of this report. The table below further summarizes the identified maintenance needs.

Work Item	Quantity	Unit	Cost
Crack Sealing - AC	17,923	Ft	\$24,734
Patching - AC Deep	837	SqFt	\$15,560
Patching - AC Shallow	82	SqFt	\$1,386
Total:			\$41,860

AC = asphalt concrete; PCC = portland cement concrete; SqFt. = square feet; Ft = linear feet

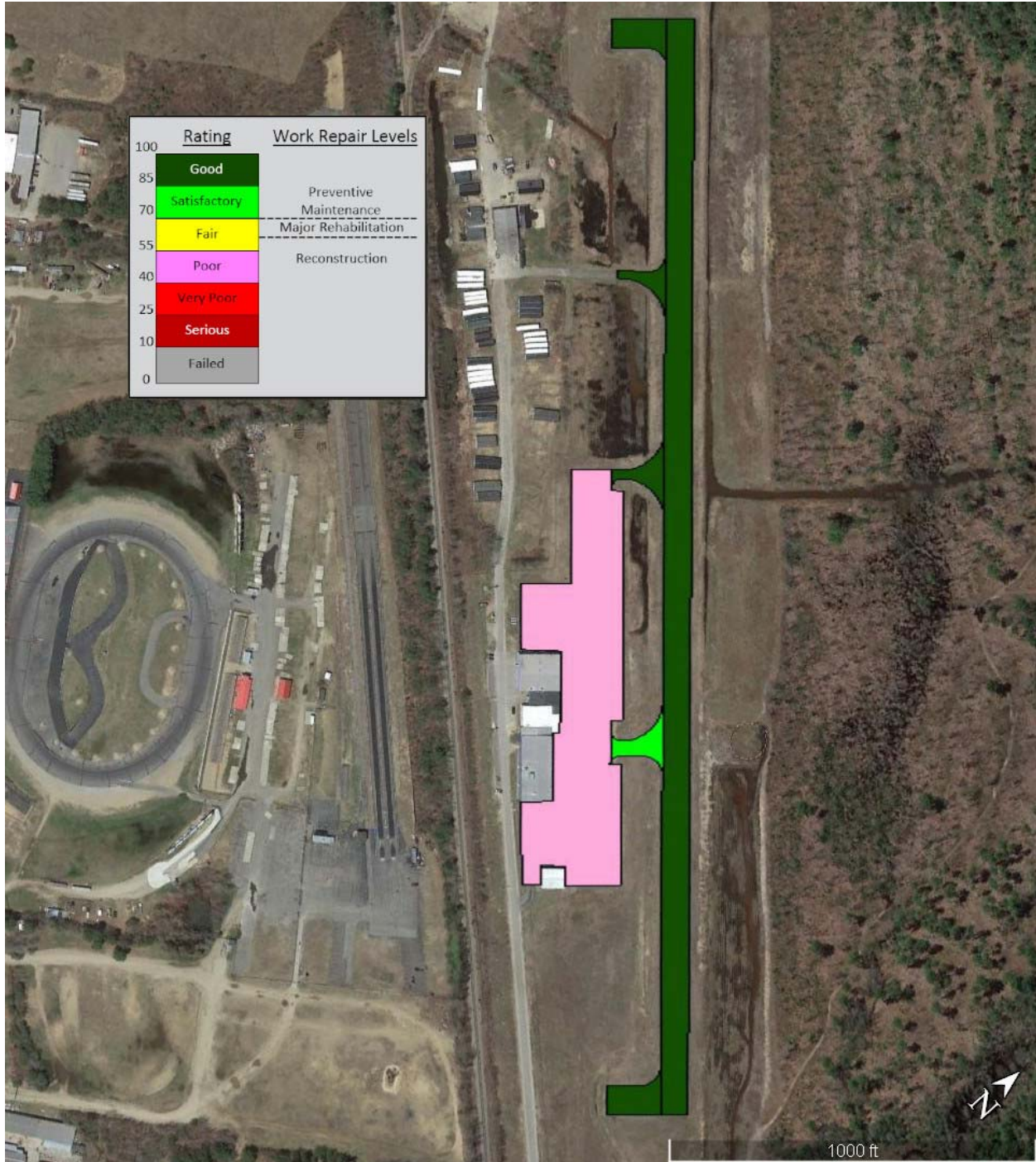

This page intentionally left blank.

Table of Contents

Executive Summary.....	i
Background.....	i
Pavement Condition	i
Capital Improvement Program	ii
Maintenance.....	ii
Table of Contents.....	v
List of Figures.....	vi
List of Tables.....	vi
Abbreviations and Acronyms.....	vii
1. Introduction.....	1
1.1 Project Background.....	1
1.2 Pavement Management Approach.....	1
1.3 Scope of Work.....	2
2. Project Approach.....	3
2.1 Update Pavement Inventory.....	3
2.1.1 Pavement Network Definition.....	3
2.1.2 Naming Scheme.....	3
2.2 Pavement Evaluation.....	7
2.2.1 Distress Types.....	8
2.3 PCI Results.....	9
2.4 Projected PCI.....	11
3. Maintenance and Rehabilitation Needs.....	15
3.1 Local M&R.....	16
3.2 Major M&R.....	20
3.3 Airfield Capital Improvement Plan - Unlimited Budget.....	22
3.4 Airport Responsibilities.....	24
Appendix A: Sample Unit Maps.....	A-1
Appendix B: Pavement Analysis.....	B-1
Appendix C: PCI Distress Report.....	C-1
Appendix D: Distress Identification.....	D-1
Appendix E: Maintenance Policies.....	E-1
Appendix F: Maintenance Repair Guidelines.....	F-1

List of Figures

Figure 1. Pavement condition life cycle.....	2
Figure 2. Network Definition at Oxford County Regional Airport (81B).....	5
Figure 3. PCI rating scale and repair levels.....	7
Figure 4. Condition distribution.....	10
Figure 5. Area-weighted PCI by pavement use.....	10
Figure 6. Projected PCI by percent area.....	11
Figure 7. 2018 PCI Map at Oxford County Regional Airport (81B).....	13
Figure 8. Maintenance type.....	19
Figure 9. Major M&R.....	21
Figure 10. Pavement failure.....	F-6
Figure 11. Crack sealing.....	F-9
Figure 12. AC crack repair.....	F-11
Figure 13. AC patch.....	F-13

List of Tables

Table 1. Branch definition.....	4
Table 2. PCI distress types.....	8
Table 3. PCI section summary table.....	9
Table 4. Projected PCI by section (no M&R).....	12
Table 5. Local M&R unit costs.....	15
Table 6. Major M&R unit costs.....	15
Table 7. Airport maintenance summary.....	16
Table 8. Maintenance type by section.....	17
Table 9. Maintenance details by section.....	18
Table 10. 5-year major rehabilitation plan.....	20
Table 11. Summary of repair needs (unlimited budget).....	22
Table 12. Projected PCI by section (unlimited funding).....	23
Table 13. Maintenance and “drive by” inspection log.....	F-14

Abbreviations and Acronyms

81B	Oxford County Regional Airport
AAC	Asphalt Overlaid with Asphalt
AC	Asphalt Concrete
APC	PCC Overlaid with Asphalt
APMS	Airport Pavement Management System
ARA	Applied Research Associates, Inc.
ASTM	American Society for Testing and Materials
CAD	Computer-aided Drafting
CIP	Capital Improvement Plan
D&K	Dubois & King, Inc.
FAA	Federal Aviation Administration
FOD	Foreign Object Debris
GIS	Geographic Information System
MaineDOT	Maine Department of Transportation
L&T	Longitudinal & Transverse Cracking
LCD	Last Construction Date
M&R	Maintenance and Rehabilitation
MSL	Minimum Service Level
PCC	Portland Cement Concrete
PCI	Pavement Condition Index

This page intentionally left blank.

1. Introduction

Pavement conditions were assessed using the Pavement Condition Index (PCI) procedure outlined in Federal Aviation Administration (FAA) Advisory Circular 150/5380 and ASTM D5340 for airfield pavements. The PCI was developed to provide a numerical value representing the overall pavement condition that correlates well with the ratings of experienced engineers. During a PCI survey, visible signs of deterioration within a selected sample unit are recorded and analyzed. The recorded distress data are used to calculate a PCI value from 0 to 100, with 100 representing a pavement in excellent condition. The PCI evaluation makes it possible to forecast future deterioration and allows for accurate projections of maintenance and rehabilitation (M&R) needs.

The data collected during this project were entered into the PAVER pavement management software program developed by the U.S. Army Corps of Engineers, Construction Engineering Research Laboratory. The capabilities of PAVER were utilized to meet the following project objectives:

- Update and store pavement inventory and condition data.
- Develop models to predict future conditions.
- Develop M&R recommendations.
- Plan budgets for future M&R needs.
- Report the results at the individual airport and statewide level.

1.1 Project Background

The 36 publicly owned airports throughout Maine play a key role in the movement of goods and services, with an estimated overall economic impact of \$1.5 billion. MaineDOT realizes the value in maintaining the paved facilities by implementing and updating an airport pavement management system (APMS). An APMS provides guidance for decisions regarding pavement M&R policies at an airport and can identify short-, medium-, and long-term rehabilitation needs, as well as provide an accessible historical record of life-extending pavement maintenance activities.

1.2 Pavement Management Approach

The main goal of any pavement management system is to identify pavements that will receive the most benefit from an optimally timed repair. By projecting the rate at which the pavement condition will deteriorate, the optimal time for applying treatments can be determined. Typically, the optimal repair time is the point at which a gradual rate of deterioration begins to increase to a much faster rate, as illustrated in Figure 1. It is critical to identify this point in time to avoid higher rehabilitation costs caused by excess deterioration.

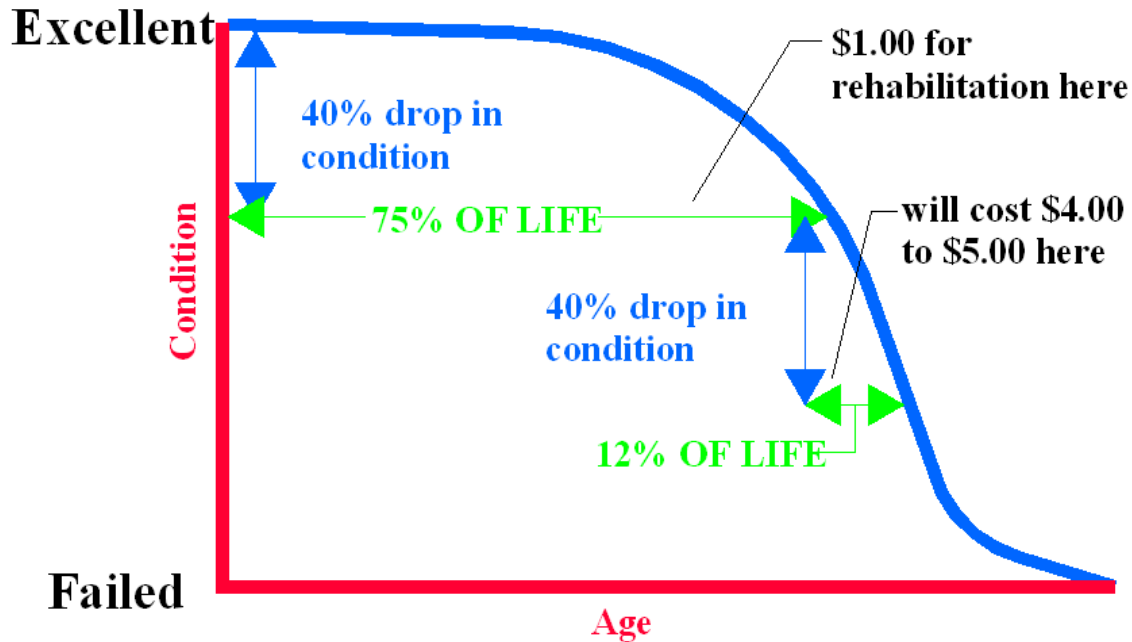

Figure 1. Pavement condition life cycle.

Often, the identified needs will cost more than the available budget and will need to be prioritized over time. The APMS can measure the impact of a limited budget scenario by projecting the future condition of deferred projects. Ultimately, the APMS will provide MaineDOT and the airport a planning tool that can help identify pavement needs, optimize the selection of projects and treatments over a multi-year period, and understand the consequences of these plans.

1.3 Scope of Work

MaineDOT retained D&K/ARA to implement the APMS for the Maine publicly owned general aviation airports. A PCI survey was completed at each airport, and available construction history information was compiled and included in the PAVER database and subsequent analysis. D&K and MaineDOT coordinated the PCI inspections with each airport. After the fieldwork was completed, ARA updated the PAVER database for each airport. PAVER was then used to develop a maintenance work plan based on current distresses. In addition, a 5-year projection identifying recommended pavement repairs was prepared at the state level for the various stakeholders to use as a planning tool. Individual reports, such as this one, were prepared for each airport documenting the results of the pavement inspections. A statewide analysis report was prepared based on that inspection year's airports. The airport maps were linked to the PAVER database to allow for geographic information system (GIS) viewing of data.

2. Project Approach

2.1 Update Pavement Inventory

The pavement inventory at 81B includes all airfield pavements intended for aviation-related traffic. The main objective in updating the pavement inventory was to determine the year of construction (or most recent overlay), the limits of the project, and the surface type for each pavement area based on construction history. When available, MaineDOT provided access to this information from their historical records. This information was used to update the pavement section definitions on the computer-aided drafting (CAD) map and in the PAVER database based on project limits, surface type, layer properties, traffic patterns, and overall condition.

2.1.1 Pavement Network Definition

The construction history information was used to divide the pavement network at 81B into management units—branches, sections, and sample units. A branch is a single entity that serves a distinct function. For example, a runway is considered a branch because it serves a single function (allowing aircraft to take off and land). On an airfield, a branch typically represents an entire runway, taxiway, or apron.

Because of the disparity of characteristics that can occur throughout a branch, it is further subdivided into units called sections. A section is a portion of the pavement that has uniform construction history, pavement structure, traffic patterns, and condition throughout its entire length or area. Sections are used as a management unit for the selection of potential M&R projects. The guideline for determining section breaks is to consider the section as a "repair unit"—a portion of the pavement that will be managed independently and evaluated separately for pavement maintenance and rehabilitation.

Pavement sections are further subdivided into sample units for inspection purposes. The typical sample unit size for asphalt concrete (AC) pavements is 5,000 square feet \pm 2,000 square feet, and the typical sample unit size for portland cement concrete (PCC) pavements is 20 slabs \pm 8 slabs. A statistical based sampling rate described in ASTM D5340 was used to determine the number of sample units to inspect for each section. The inspected sample units were representative of the overall condition within a section and were used to extrapolate the condition as a whole.

2.1.2 Naming Scheme

For the pavement management system to work efficiently, some unique identifiers were added to the database. The branch names assigned were designed to assist in identification of the pavement area. The first characters are used to identify the pavement use—apron, runway, taxiway, or taxilane (pavement in and around hangar areas). The next character is a number or letter used to further identify the pavement branch (such as RY1533 for Runway 15-33 or APA for Apron A). The sections for each branch are assigned a sequential number (001, 002, and so on). Table 1 presents the branches defined for 81B and their corresponding areas.

Table 1. Branch definition.

Branch ID	Name	Number of Sections	Area (SF)
APA	Apron A	1	222,800
CTA	Connecting Taxiway A	1	9,600
CTB	Connecting Taxiway B	1	9,200
CTC	Connecting Taxiway C	1	6,050
RTA	Runway Turnaround A	1	12,450
RTB	Runway Turnaround B	1	12,650
RY1533	Runway 15-33	1	225,150
Airport Total			497,900

Figure 2 presents the network definition for 81B and represents the pavements included in the APMS. Some privately built/maintained pavements and “driveways” leading into hangars may not be included within this report nor represented on Figure 2 because they are considered outside the scope of work.

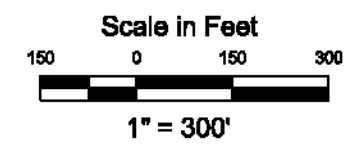
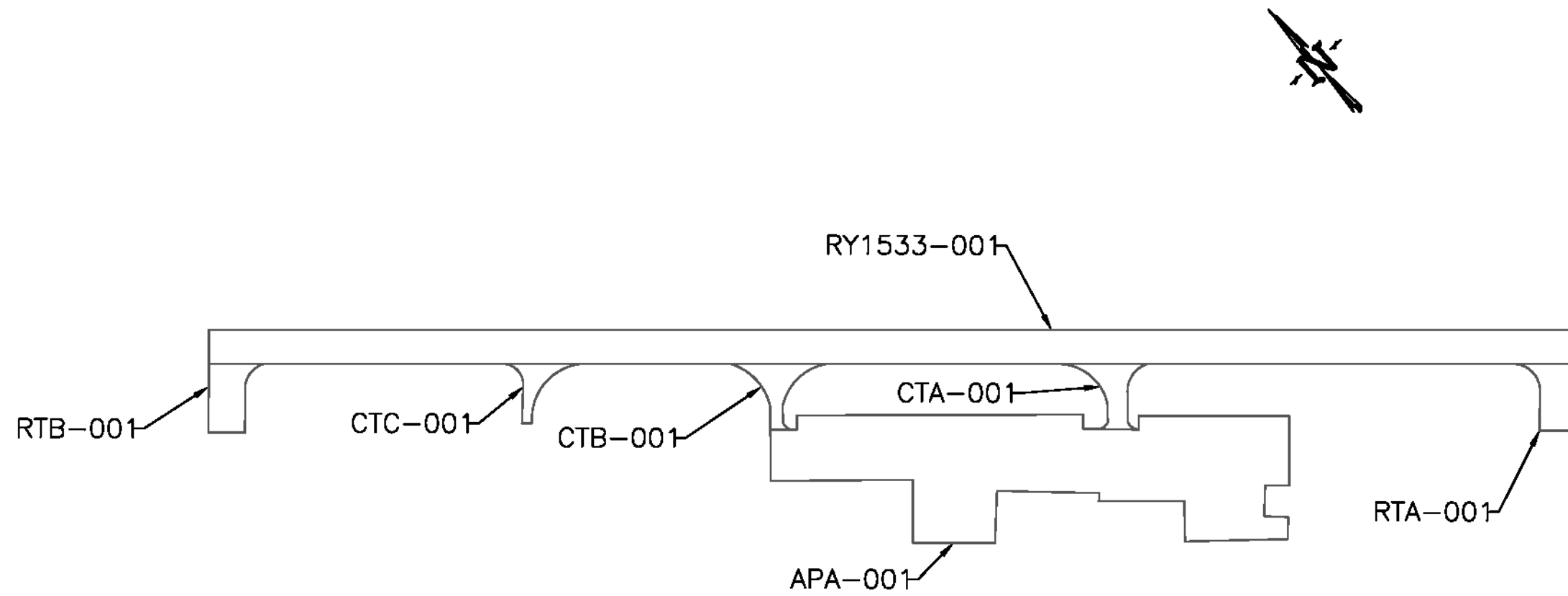

Network Definition Oxford County Regional Airport (81B)			
ENGINEER:	DRAWN BY:	DATE:	CTAF
BDA	MJP	Jul 2019	122.8

Figure 2. Network Definition at Oxford County Regional Airport (81B)

2.2 Pavement Evaluation

The pavement surfaces at 81B were visually inspected on November 10, 2018 using the PCI procedure. During a PCI inspection, inspectors walk over the surface of the pavement and identify visible signs of distress within a sample unit. Appendix A presents the scalable map used during the inspection to locate the inspected sample units. Each distress type was identified, then classified as low, medium, or high severity, and recorded on field sheets. In general, the higher the severity, the higher the foreign object damage (FOD) potential. The quantity, or extent, is measured for each distress/severity combination.

After collecting and summarizing the distress type, severity, and quantity for each of the inspected sample units, the distress data were entered into the PAVER database and a PCI was calculated. The PCI procedure uses established deduct curves to determine the number of points to deduct for each distress type/severity combination, depending on the density of the distress. The inspected sample unit PCIs were then averaged to determine an overall PCI for that section.

The PCI value provides a general sense as to the level of rehabilitation that will be needed to repair a given pavement. In general terms, maintenance activities such as crack sealing and patching often provide benefit when the PCI is above 70. However, as the pavement continues to deteriorate, more complex and expensive treatments will be necessary. Pavements with a PCI between 60 and 70 are good candidates for a mill and inlay or overlay. Once the PCI drops below 60, MaineDOT typically programs reconstruction as the preferred rehabilitation alternative. Figure 3 presents the PCI inputs, rating scale, and corresponding general work repair levels.

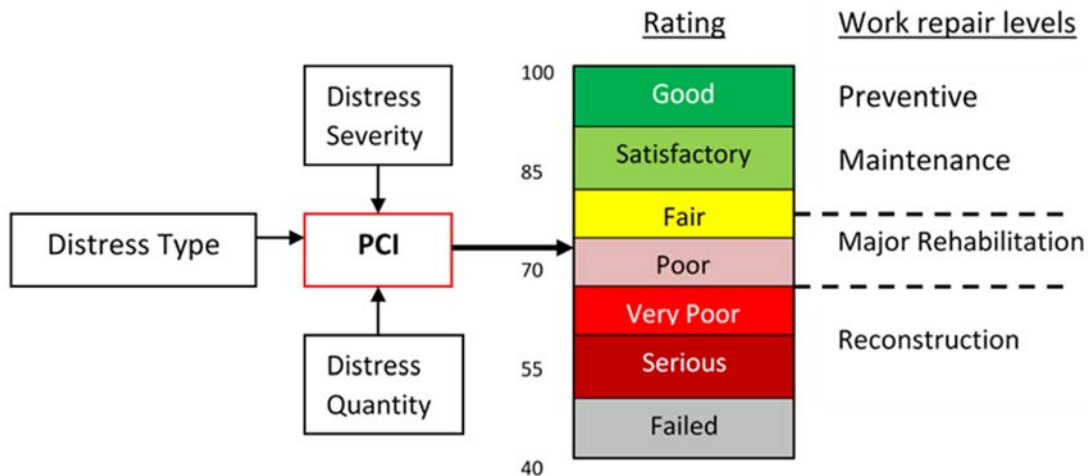

Figure 3. PCI rating scale and repair levels.

2.2.1 Distress Types

To better understand the cause of pavement deterioration, it is necessary to look at the distress types associated with each PCI. Each distress type has been classified into one of three groups based on cause—load, climate/durability, or other. Load-related distresses such as alligator cracking in asphalt pavements, or corner breaks in PCC pavements, indicate that the structural integrity of the pavement has been compromised. Climate-related distresses indicate that the pavement has aged due to seasonal environmental effects. Distresses that cannot be attributed solely to either load or climate are classified as other. Table 2 shows distress types for both asphalt and concrete surfaced pavements in the PCI procedure and their classification. The table also identifies which distresses were observed at 81B during the pavement inspection.

Table 2. PCI distress types.

Asphalt Distresses	Cause Classification	Concrete Distresses	Cause Classification
*Alligator cracking	*Load	Blowup	Climate
Bleeding	Other	Corner break	Load
Block cracking	Climate	Linear cracking	Load
Corrugation	Other	Durability cracking	Climate
Depression	Other	Joint seal damage	Climate
Jet blast	Other	Small patch	Other
Joint reflection cracking	Climate	Large patch	Other
*L&T cracking	*Climate	Popouts	Other
Oil spillage	Other	Pumping	Other
*Patching	*Other	Scaling/crazing	Other
Polished aggregate	Other	Faulting	Other
Raveling	Climate	Shattered slab	Load
Rutting	Load	Shrinkage cracking	Other
Shoving	Other	Joint spalling	Other
Slippage cracking	Other	Corner spalling	Other
*Swelling	*Other	Alkali silica reaction	Climate
Weathering	Climate		

* Indicates distresses found at 81B

2.3 PCI Results

The results of the 2018 PCI inspection are presented in Table 3 and Figure 7. The overall area-weighted PCI for 81B is 73. When summarizing PCI values, an area-weighted calculation is used instead of a straight mathematical average because the area-weighted calculations eliminate the skewing of the PCI due to disparities between section sizes.

Figure 4 and Figure 5 present the overall PCI for 81B by area distribution and pavement use, respectively. Table 3 presents the PCI summary for each section at 81B, including the drop in PCI per year. Generally, pavement sections will deteriorate between 1 and 3 PCI points per year. Sections deteriorating at higher rates may need maintenance above the normal application rates and should be closely monitored in case major repairs become necessary earlier than expected.

Appendix B provides a graphical illustration of the projected PCI for each pavement section along with additional summary data including various repair alternatives. Appendix C contains the detailed inspection report with sample unit data produced from PAVER. Appendix D describes the distress types most commonly identified during the PCI inspections of Maine airports.

Table 3. PCI section summary table.

Branch ID	Section ID	Surface Type ¹	Section Area (SF)	LCD ²	2018 PCI	Drop in PCI/Yr ³	% Deduct due to	
							Load	Climate
APA	001	AC	222,800	1973	55	1.0	23	77
CTA	001	AC	9,600	2009	83	1.9	0	100
CTB	001	AC	9,200	2009	90	1.1	0	81
CTC	001	AC	6,050	2009	89	1.2	34	7
RTA	001	AC	12,450	2009	92	0.9	0	100
RTB	001	AC	12,650	2009	96	0.4	0	100
RY1533	001	AC	225,150	2009	88	1.3	0	100

¹ AC = asphalt cement; AAC = asphalt overlaid with asphalt; PCC = portland cement concrete; APC = PCC overlaid with asphalt

² LCD = last construction date (original construction, last overlay, or reconstruction [whichever is most recent])

³ Drop in PCI/Yr = (100 – PCI)/age where age = 2018 – LCD

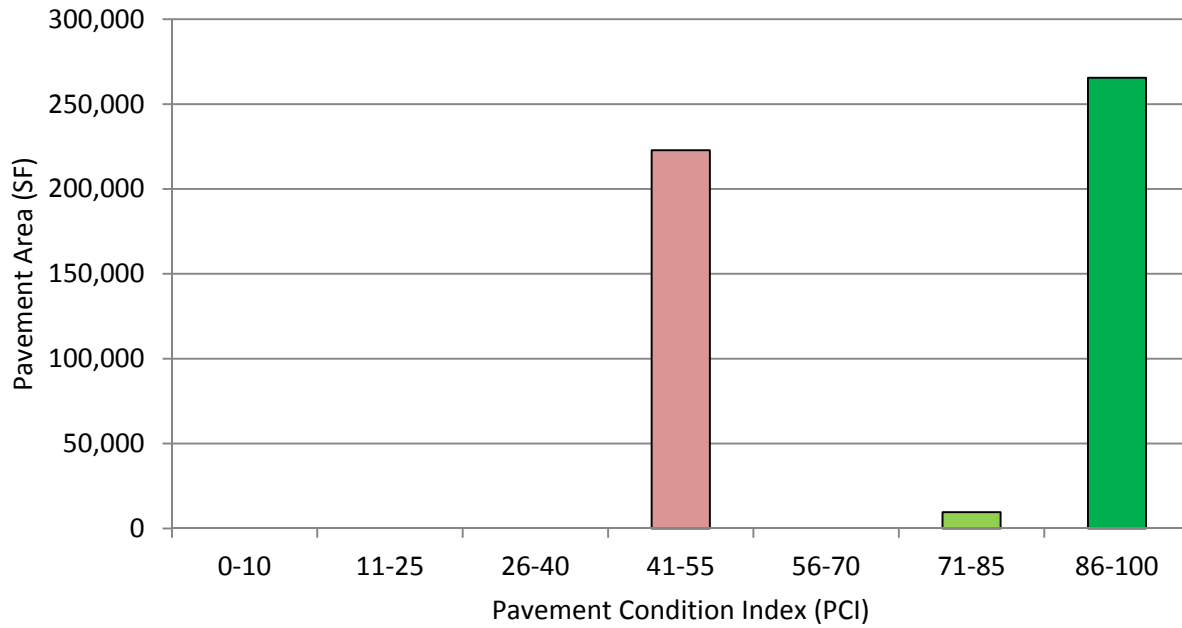

Figure 4. Condition distribution.

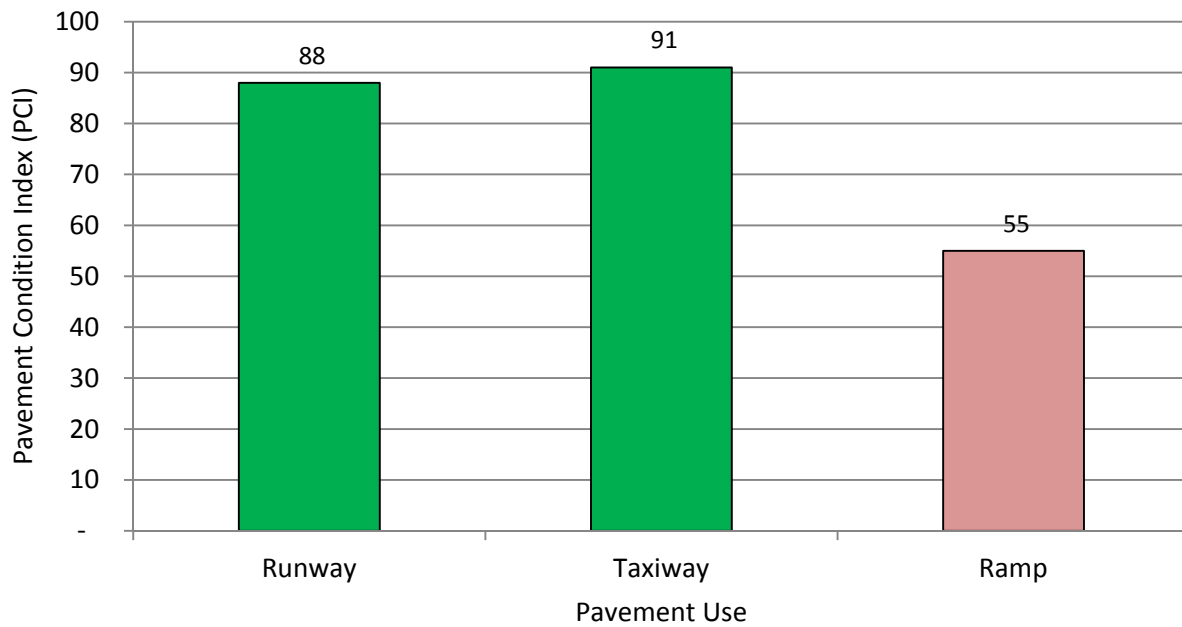

Figure 5. Area-weighted PCI by pavement use.

2.4 Projected PCI

After the 2018 distress data were entered into PAVER and the PCI determined, a modeling approach was used to predict future PCI levels based on historical PCI data from MaineDOT's airports. Pavements were grouped together in performance families based on similar construction, traffic, pavement use, and other factors affecting pavement performance. These performance models predict future PCI, not future distresses.

Figure 6 shows the projected PCI at 81B by percent area for the next 5 years assuming no maintenance or major repairs (overlays, reconstruction, etc.) are performed during that period. It shows how quickly the pavement network will deteriorate if no capital improvements are made. The corresponding projected PCI values for each pavement section are shown in Table 4.

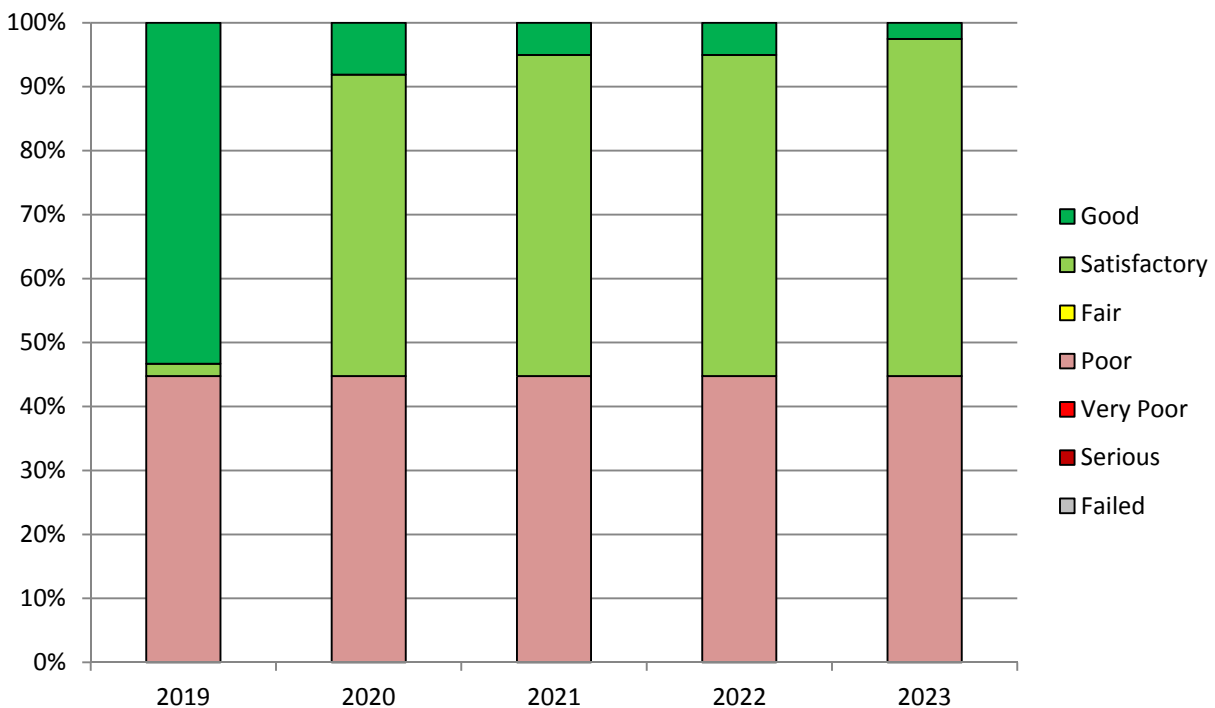
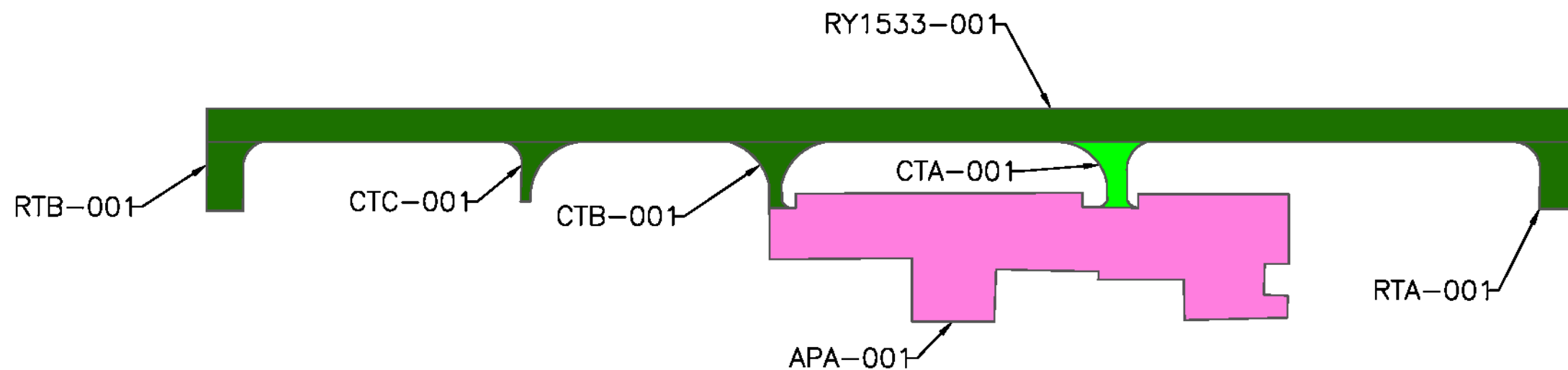

Figure 6. Projected PCI by percent area.

Table 4. Projected PCI by section (no M&R).

Branch ID	Section ID	2019	2020	2021	2022	2023
APA	001	53	51	49	47	45
CTA	001	82	80	78	77	75
CTB	001	89	87	85	84	82
CTC	001	88	86	84	83	81
RTA	001	91	89	88	86	84
RTB	001	95	93	92	90	89
RY1533	001	87	85	83	82	80



	FAILED	SERIOUS	VERY POOR	POOR	FAIR	SATISFACTORY	GOOD	PCI INDEX
NS	0-10	11-25	26-40	41-55	56-70	71-85	86-100	

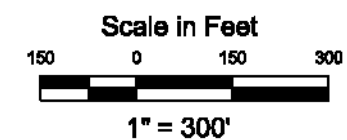

2018 Pavement Condition Map Oxford County Regional Airport (81B)			
ENGINEER:	DRAWN BY:	DATE:	CTAF
BDA	MJP	Jul 2019	122.8

Figure 7. 2018 PCI Map at Oxford County Regional Airport (81B)

3. Maintenance and Rehabilitation Needs

A 5-year M&R program was developed for 81B based on the 2018 pavement inspections and the projected PCI deterioration. The recommendations are divided into two categories—near term maintenance (local M&R) and major rehabilitation (major M&R). The near term maintenance is intended to address annual maintenance needs such as crack sealing and localized patching. The major rehabilitation treatments are applied globally and are capable of returning the pavement to a nearly distress-free state. Costs for both categories were developed based on recent bid tabs and are intended to represent typical unit costs in Maine. While these cost estimates provide a useful network-level planning tool, they are not meant to represent an engineer’s estimate for any particular project. Project-specific cost estimates must be developed on a case-by-case basis.

Table 5 shows the unit costs used to determine the near term maintenance needs and Table 6 shows the unit costs used to determine the major rehabilitation needs. Unlike the maintenance costs based on specific action items, PAVER estimates major rehabilitation costs based on the PCI value. Therefore, the costs shown in Table 6 are meant to represent a unit cost for complete reconstruction (PCI < 60) of \$31.01 for PCC and \$20.40 for AC pavement. For major rehabilitation (PCI between 61 and 70), unit costs are \$8.75 for PCC and \$2.75 for AC pavement. Note that the unit cost of \$2.75 between PCI values of 61 and 70 for AC pavement represents the cost of a 2-inch mill and inlay.

Table 5. Local M&R unit costs

Treatment Name	Unit Cost
Crack Sealing - AC	\$1.38 / Ft
Crack Sealing - PCC	\$3.93 / Ft
Grinding (Localized)	\$5.75 / Ft
Joint Seal (Localized)	\$3.85 / Ft
Patching - AC Deep	\$18.56 / SqFt
Patching - AC Shallow	\$16.81 / SqFt
Surface Treatment	\$0.61 / SqFt
Patching - PCC Full Depth	\$119.00 / SqFt
Patching - PCC Partial Depth	\$61.63 / SqFt
Slab Replacement - PCC	\$31.55 / SqFt
Undersealing - PCC	\$3.03 / Ft

Table 6. Major M&R unit costs

PCI	Cost AC	Cost PCC
0-60	\$20.40 / SqFt	\$31.01 / SqFt
61-70	\$2.75 / SqFt	\$8.75 / SqFt
71-80	\$1.10 / SqFt	\$5.45 / SqFt
81-100	\$0.61 / SqFt	\$0.61 / SqFt

3.1 Local M&R

Near term maintenance includes activities such as crack sealing, patching, and surface treatments that help to slow the rate of deterioration. Localized maintenance policies were developed for the AC and PCC surfaces. The policies, provided in appendix E, present the recommended maintenance treatment for each distress/severity combination.

Table 7 presents the summary of maintenance work quantities and estimated costs to apply the near term maintenance plan at 81B. The repair quantities are based on extrapolated distress quantities from PAVER using the 2018 PCI inspection and the maintenance policy matrix as defined in appendix E.

Table 7. Airport maintenance summary

Treatment	Estimated Repair Quantity	Units	Estimated Costs
Crack Sealing - AC	17,923	Ft	\$24,734
Patching - AC Deep	837	SqFt	\$15,560
Patching - AC Shallow	82	SqFt	\$1,386
Total:			\$41,680

When using this plan, it is recommended that the entire pavement section be viewed to determine whether the identified distress types are so advanced in density and severity that maintenance efforts will no longer be cost-effective. Table 8 provides a more detailed breakdown of the maintenance needs with each pavement section classified as preventive, restorative, or stopgap. Preventive maintenance is defined as occurring above the minimum service level (MSL) and is recommended as a cost-effective means of prolonging the pavement life. Restorative maintenance occurs below the MSL but has the ability to increase the PCI above the MSL. It is recommended that the airport engineer perform a life cycle cost analysis comparing restorative maintenance to major rehabilitation to determine the ideal repair strategy. Stopgap maintenance is defined as maintenance needs that will not restore the pavement to the MSL. Stopgap maintenance is typically limited to the minimum necessary to control FOD and maintain safety until such time as major rehabilitation can be programmed.

Table 8. Maintenance type by section

Branch	Section	Maintenance Type	PCI Before	PCI After	Cost
APA	001	Restorative	55	70	\$40,230
CTA	001	Preventive	83	89	\$64
CTC	001	Preventive	89	91	\$1,386

It is important to understand that the maintenance plan is based on the distress types, severities, and quantities found during the 2018 PCI survey. As field conditions change, the maintenance plan will become less accurate. Therefore, the maintenance plan will be most useful if implemented as soon as is practical. Applying maintenance treatments should be an annual event at the airport, and this maintenance plan can serve as a baseline for that work. The recommended maintenance type for each section is shown in Figure 9 and summarized in Table 8. Recommended maintenance actions by section are provided in Table 9. Guidelines for performing crack sealing and patching techniques are provided in appendix F.

Table 9. Maintenance details by section

Branch	Section	Work Type	Quantity	Unit	Cost
APA	001	Crack Sealing - AC	17,877	Ft	\$24,670
APA	001	Patching - AC Deep	837	SqFt	\$15,560
CTA	001	Crack Sealing - AC	46	Ft	\$64
CTC	001	Patching - AC Shallow	83	SqFt	\$1,386

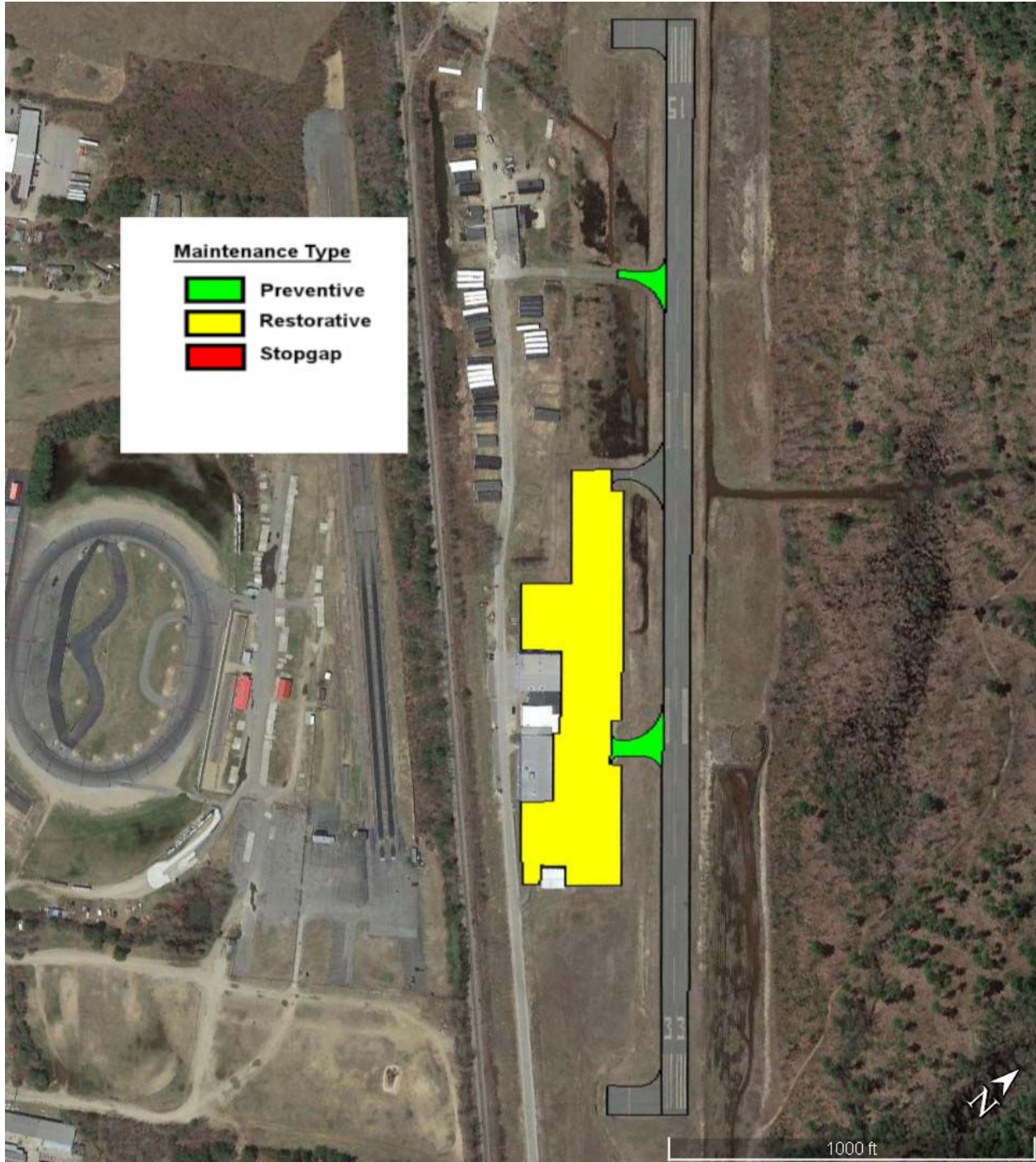

Figure 8. Maintenance type

3.2 Major M&R

In addition to the annual maintenance activities such as crack sealing and patching, some pavements may require more substantial rehabilitation. As a planning aid to the airport and MaineDOT, Table 10 provides a summary from PAVER of the predicted 5-year pavement rehabilitation needs at 81B. The recommended timing of each improvement action is defined as the year that the pavement condition is projected to reach the MSL. By establishing benchmark MSL targets, it is possible to plan objectively for future needs against a standard set of performance criteria. Based on D&K/ARA's recommendations and a review of national best practices, MaineDOT Division of Aviation has selected benchmark MSL values of 70 for all airside pavement. These MSL values fall within the typical range of those used throughout the nation to manage general aviation airport pavement.

The pavement sections identified for major rehabilitation in Table 10 and shown in Figure 9 are at or are predicted to reach a condition level where major M&R should be considered. While the predicted rehabilitation timeline identifies specific sections and the general timing for the repair, more in-depth project-level studies will be needed to determine exactly how to fix each pavement (i.e. asphalt overlay, reconstruction, or some other repair alternative). Additionally, the airport may find it desirable to adjust the timing of projects to meet fiscal and operational constraints. For example, if the runway and several connector taxiways were forecast to reach the MSL in various years ranging from 2019-2023, it may be preferable to group these pavement sections into a single project.

Note that identifying projects for work does not guarantee that federal or state funding will be available to complete the work in the year shown. The airport and MaineDOT should view these recommendations as viable projects when preparing future capital improvement plans (CIP).

Table 10. 5-year major rehabilitation plan.

Branch ID	Section ID	Year	Predicted PCI Before Rehab	Estimated Cost
APA	001	2020	51	\$4,545,042
5-year Airport Total				\$4,545,042

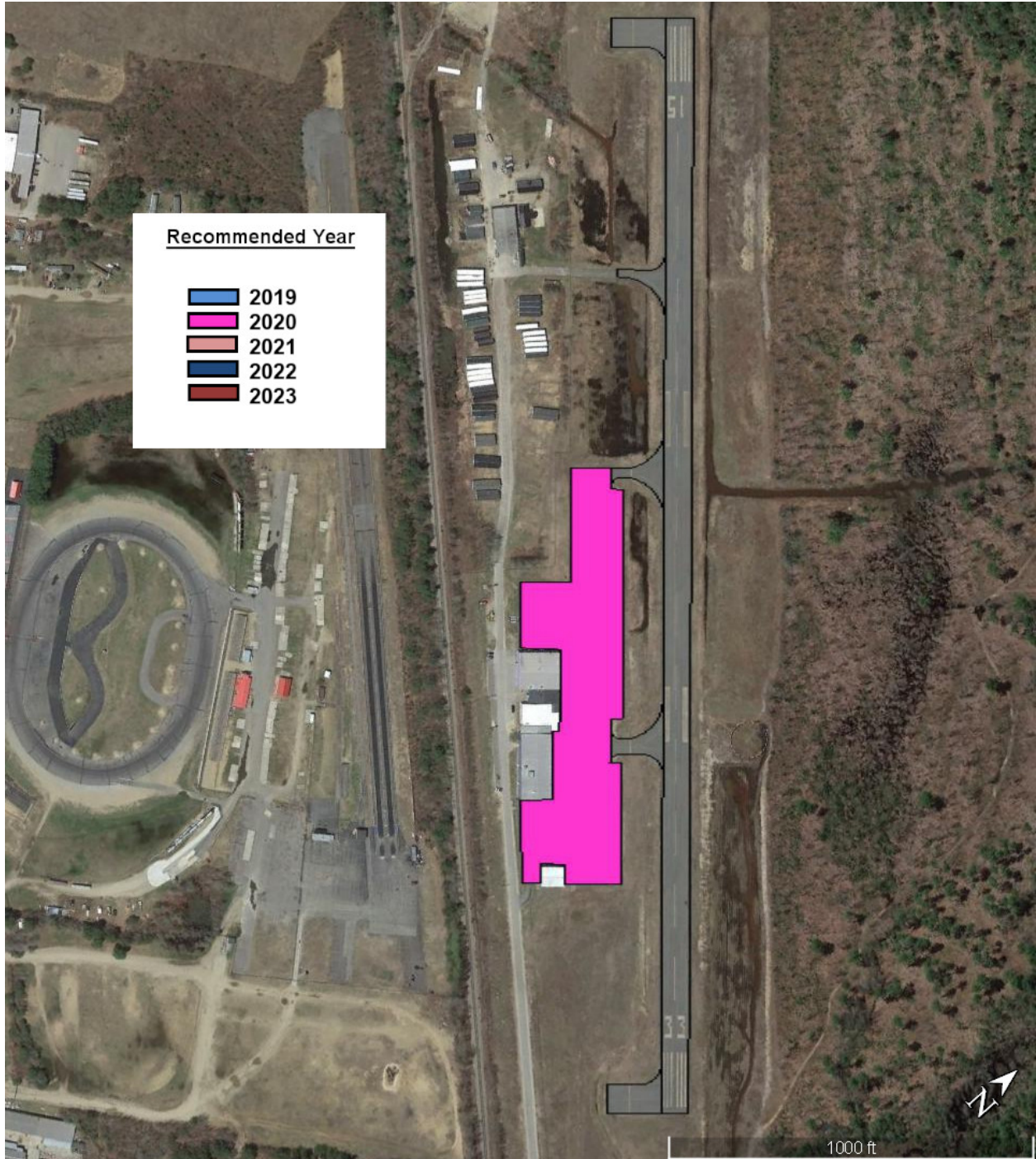

Figure 9. Major M&R

3.3 Airfield Capital Improvement Plan - Unlimited Budget

Assuming that all pavement sections below the MSL receive major M&R and that all pavement sections above the MSL receive preventive maintenance, the total funding needs for the identified maintenance and rehabilitation projects at 81B are shown in Table 11. Note that funding sources will vary by airport, but it is generally assumed that major M&R projects will be eligible for FAA AIP funding and that preventive maintenance will be completed with airport/city staff. Pavement sections, where restorative maintenance appears to be a cost effective alternative to major M&R, have been flagged for additional analysis by the airport sponsor / design engineer. If this pavement repair plan were to be implemented as shown, the subsequent projected PCI values for each pavement section are shown in Table 12.

Table 11. Summary of repair needs (unlimited budget)

Branch ID	Section ID	Year	Type of Repair	Funding Sources	Cost
APA	001	2020	Major M&R	FAA/Local	\$4,545,042
CTA	001	2020	Preventive Maintenance	Local / City Crew	\$64
CTB	001	2020	No Action		
CTC	001	2020	Preventive Maintenance	Local / City Crew	\$1,386
RTA	001	2020	No Action		
RTB	001	2020	No Action		
RY1533	001	2020	No Action		
APA	001	2023	Preventive Maintenance	Local / City Crew	\$2,228
CTA	001	2023	Preventive Maintenance	Local / City Crew	\$289
CTB	001	2023	Preventive Maintenance	Local / City Crew	\$299
CTC	001	2023	Preventive Maintenance	Local / City Crew	\$34
RTA	001	2023	Preventive Maintenance	Local / City Crew	\$388
RTB	001	2023	Preventive Maintenance	Local / City Crew	\$94
RY1533	001	2023	Preventive Maintenance	Local / City Crew	\$12,795
Total:					\$4,562,619

Table 12. Projected PCI by section (unlimited funding)

Branch ID	Section ID	2019	2020	2021	2022	2023
APA	001	53	100	98	96	95
CTA	001	82	89	87	86	84
CTB	001	89	87	85	84	82
CTC	001	88	91	90	88	86
RTA	001	91	89	88	86	84
RTB	001	95	93	92	90	89
RY1533	001	87	85	83	82	80

3.4 Airport Responsibilities

The FAA has defined an acceptable maintenance-management program, and this report fulfills many requirements of such a program, including documenting:

- Locations of all runways, taxiways, and aprons.
- Dimensions of the pavement system.
- Types of pavement.
- Year of construction or most recent major rehabilitation.

In accordance with best practices, the airport owner should be an active participant specifically by implementing the following actions:

- Conduct a "drive-by" inspection at least monthly to detect changes in pavement condition.
- Record the date of each "drive-by" inspection and any maintenance performed as a result.
- Document all maintenance activities.
- Document detailed inspection information with a history of recorded pavement deterioration by PCI survey (e.g., this report).
- Maintain all records on file for a minimum of 5 years.

An example of a form that can be completed during "drive-by" inspections is provided in appendix F.

Appendix A: Sample Unit Maps

This page intentionally left blank.

- Denotes sample unit surveyed
- ◇ Denotes additional sample unit surveyed

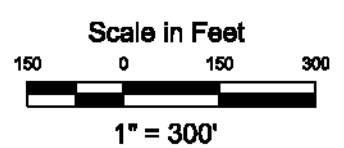
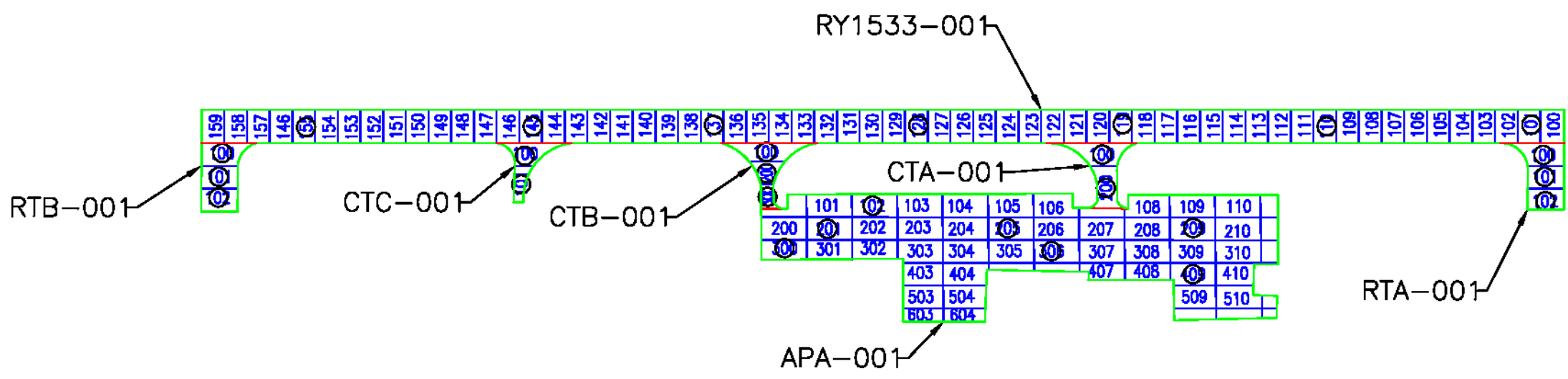

Sample Unit Layout at Oxford County Regional Airport (81B)			
ENGINEER: BDA	DRAWN BY: MJP	DATE: Jul 2019	CTAF 122.8

Figure A1. Sample Unit Layout at Oxford County Regional Airport (81B)

Appendix B: Pavement Analysis

This page intentionally left blank.

ARAPA

ARA Pavement Analysis

Section:	81B::APA::001
Description:	Apron A
PaveType:	AC
Area:	222,800
Built:	1/15/1973
Age:	46yr

InspPCI:	55
InspPCI Rating:	Poor
InspDate:	11/10/2018
PCI Family:	2019 MAINE AC APRON-TLN
NormalPCI:	7
MSL:	70

Work History	Year	Thickness (in)	Type
1	2000	0.0	crack sealing - ac
2	1989	0.0	crack sealing - ac
3	1973	0.0	new construction - ac
4	1973	2.0	surface course - ac (layer construct)
5	1973	6.0	base course - aggregate
6	-	-	-
7	-	-	-
8	-	-	-
9	-	-	-
10	-	-	-

Basic Cause of Distress:

Traffic/Load:	23%	Total Samples:	45
Age/Weather:	77%	Insp. Samples:	7
Other:	0%		

Extrapolated Distress:	Type	Quantity	Severity	Units
1	alligator	725	medium	SqFt
2	l & t crack	9,598	low	Ft
3	l & t crack	16,605	medium	Ft
4	l & t crack	1,272	high	Ft
5	patch	2,637	low	SqFt
6	-	-	-	-
7	-	-	-	-
8	-	-	-	-
9	-	-	-	-
10	-	-	-	-
11	-	-	-	-
12	-	-	-	-
13	-	-	-	-
14	-	-	-	-
15	-	-	-	-
16	-	-	-	-
17	-	-	-	-
18	-	-	-	-
19	-	-	-	-
20	-	-	-	-

ARA Pavement Analysis

Section:

81B::APA::001

Description:

Apron A

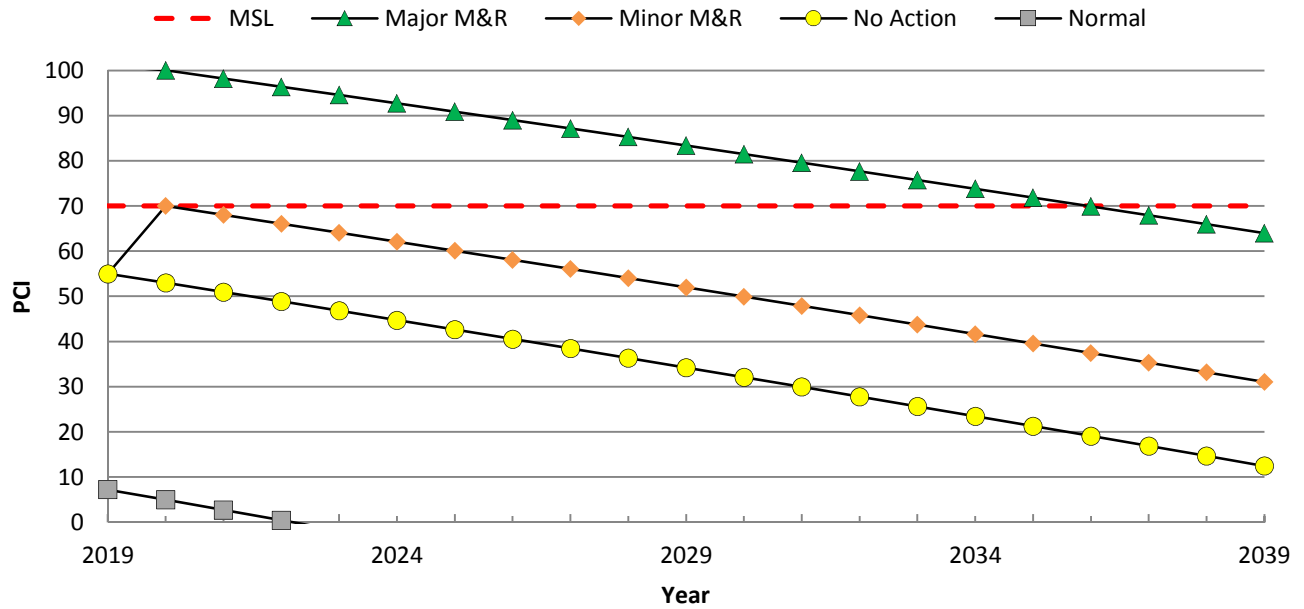

M&R	Action	Year / Quantity	Cost (\$)	Ending PCI
Major	Major M&R	2020	4,545,042	100
Minor	All Minor	2020	40,230	70
1	Crack Sealing - AC	17877 Ft	24,670	-
2	Patching - AC Deep	837 SqFt	15,560	-
3	-	-	-	-
4	-	-	-	-
5	-	-	-	-
6	-	-	-	-
7	-	-	-	-



ARA Pavement Analysis

Section:	81B::CTA::001
Description:	Connecting Taxiway A
PaveType:	AC
Area:	9,600
Built:	1/15/2009
Age:	10yr

InspPCI:	83
InspPCI Rating:	Satisfactory
InspDate:	11/10/2018
PCI Family:	2019 MAINE AC RW-TW
NormalPCI:	85
MSL:	70

Work History	Year	Thickness (in)	Type
1	2009	0.0	complete reconstruction - ac
2	2009	3.0	surface course - ac (layer construct)
3	2009	6.0	base course - aggregate
4	2000	0.0	crack sealing - ac
5	1989	0.0	crack sealing - ac
6	-	-	-
7	-	-	-
8	-	-	-
9	-	-	-
10	-	-	-

Basic Cause of Distress:

Traffic/Load:	0%	Total Samples:	2
Age/Weather:	100%	Insp. Samples:	2
Other:	0%		

Extrapolated Distress:	Type	Quantity	Severity	Units
1	l & t crack	191	low	Ft
2	l & t crack	19	medium	Ft
3	l & t crack	28	high	Ft
4	-	-	-	-
5	-	-	-	-
6	-	-	-	-
7	-	-	-	-
8	-	-	-	-
9	-	-	-	-
10	-	-	-	-
11	-	-	-	-
12	-	-	-	-
13	-	-	-	-
14	-	-	-	-
15	-	-	-	-
16	-	-	-	-
17	-	-	-	-
18	-	-	-	-
19	-	-	-	-
20	-	-	-	-

ARA Pavement Analysis

Section:

81B::CTA::001

Description:

Connecting Taxiway A

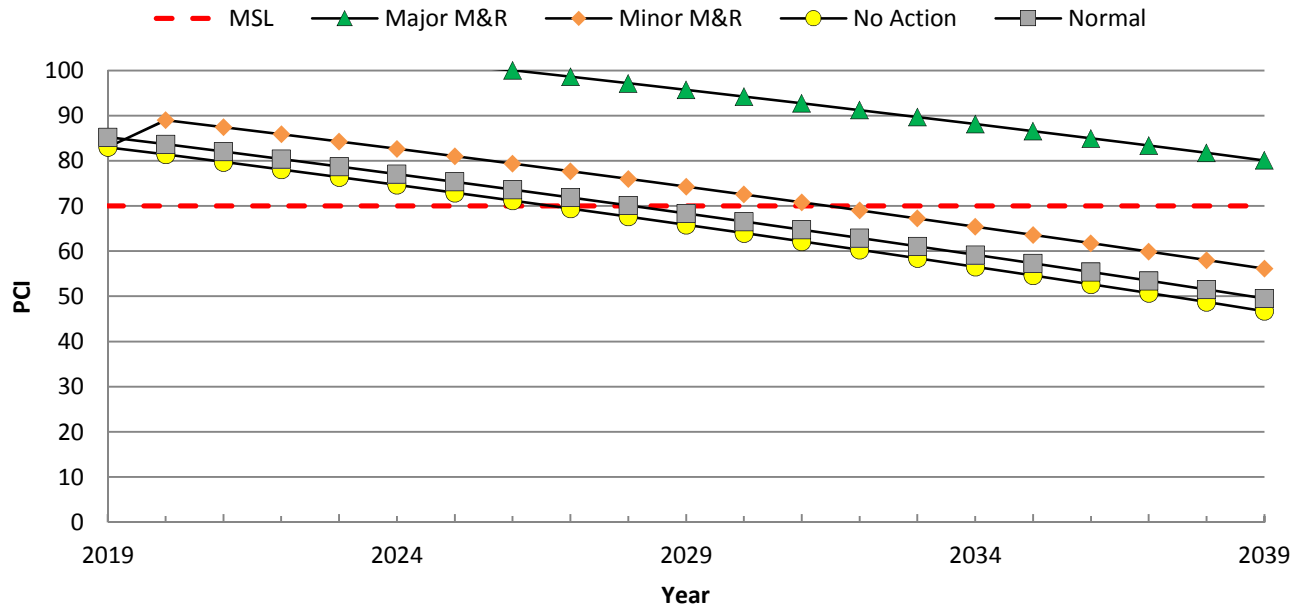

M&R	Action	Year / Quantity	Cost (\$)	Ending PCI
Major	Major M&R	2026	26,399	100
Minor	All Minor	2020	64	89
1	Crack Sealing - AC	46 Ft	64	-
2	-	-	-	-
3	-	-	-	-
4	-	-	-	-
5	-	-	-	-
6	-	-	-	-
7	-	-	-	-



ARA Pavement Analysis

Section:	81B::CTB::001
Description:	Connecting Taxiway B
PaveType:	AC
Area:	9,200
Built:	1/15/2009
Age:	10yr

InspPCI:	90
InspPCI Rating:	Good
InspDate:	11/10/2018
PCI Family:	2019 MAINE AC RW-TW
NormalPCI:	85
MSL:	70

Work History	Year	Thickness (in)	Type
1	2009	0.0	complete reconstruction - ac
2	2009	3.0	surface course - ac (layer construct)
3	2009	6.0	base course - aggregate
4	2000	0.0	crack sealing - ac
5	1989	0.0	crack sealing - ac
6	-	-	-
7	-	-	-
8	-	-	-
9	-	-	-
10	-	-	-

Basic Cause of Distress:

Traffic/Load:	0%	Total Samples:	3
Age/Weather:	81%	Insp. Samples:	3
Other:	19%		

Extrapolated Distress:	Type	Quantity	Severity	Units
1	l & t crack	217	low	Ft
2	swell	49	low	SqFt
3	-	-	-	-
4	-	-	-	-
5	-	-	-	-
6	-	-	-	-
7	-	-	-	-
8	-	-	-	-
9	-	-	-	-
10	-	-	-	-
11	-	-	-	-
12	-	-	-	-
13	-	-	-	-
14	-	-	-	-
15	-	-	-	-
16	-	-	-	-
17	-	-	-	-
18	-	-	-	-
19	-	-	-	-
20	-	-	-	-

ARA Pavement Analysis

Section:

81B::CTB::001

Description:

Connecting Taxiway B

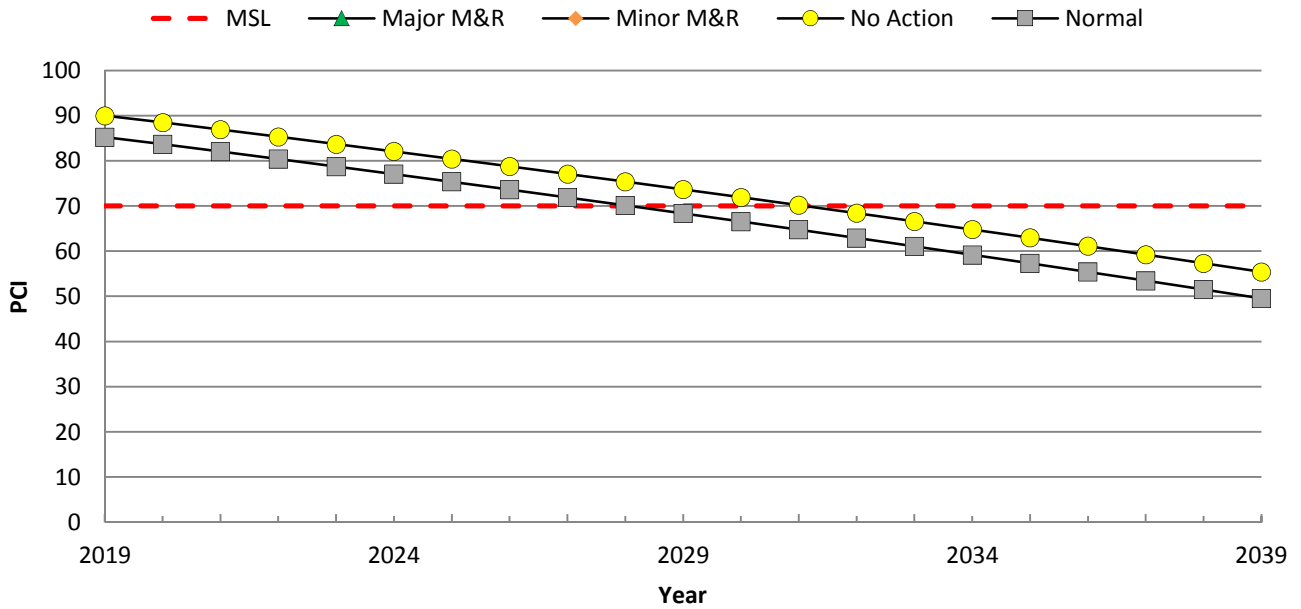

M&R	Action	Year / Quantity	Cost (\$)	Ending PCI
Major	-	-	-	-
Minor	-	-	-	-
1	-	-	-	-
2	-	-	-	-
3	-	-	-	-
4	-	-	-	-
5	-	-	-	-
6	-	-	-	-
7	-	-	-	-



ARA Pavement Analysis

Section:	81B::CTC::001
Description:	Connecting Taxiway C
PaveType:	AC
Area:	6,050
Built:	1/15/2009
Age:	10yr

InspPCI:	89
InspPCI Rating:	Good
InspDate:	11/10/2018
PCI Family:	2019 MAINE AC RW-TW
NormalPCI:	85
MSL:	70

Work History	Year	Thickness (in)	Type
1	2009	0.0	complete reconstruction - ac
2	2009	3.0	surface course - ac (layer construct)
3	2009	6.0	base course - aggregate
4	-	-	-
5	-	-	-
6	-	-	-
7	-	-	-
8	-	-	-
9	-	-	-
10	-	-	-

Basic Cause of Distress:

Traffic/Load:	34%	Total Samples:	2
Age/Weather:	7%	Insp. Samples:	2
Other:	59%		

Extrapolated Distress:	Type	Quantity	Severity	Units
1	alligator	50	low	SqFt
2	l & t crack	24	low	Ft
3	swell	50	high	SqFt
4	-	-	-	-
5	-	-	-	-
6	-	-	-	-
7	-	-	-	-
8	-	-	-	-
9	-	-	-	-
10	-	-	-	-
11	-	-	-	-
12	-	-	-	-
13	-	-	-	-
14	-	-	-	-
15	-	-	-	-
16	-	-	-	-
17	-	-	-	-
18	-	-	-	-
19	-	-	-	-
20	-	-	-	-

ARA Pavement Analysis

Section:

81B::CTC::001

Description:

Connecting Taxiway C

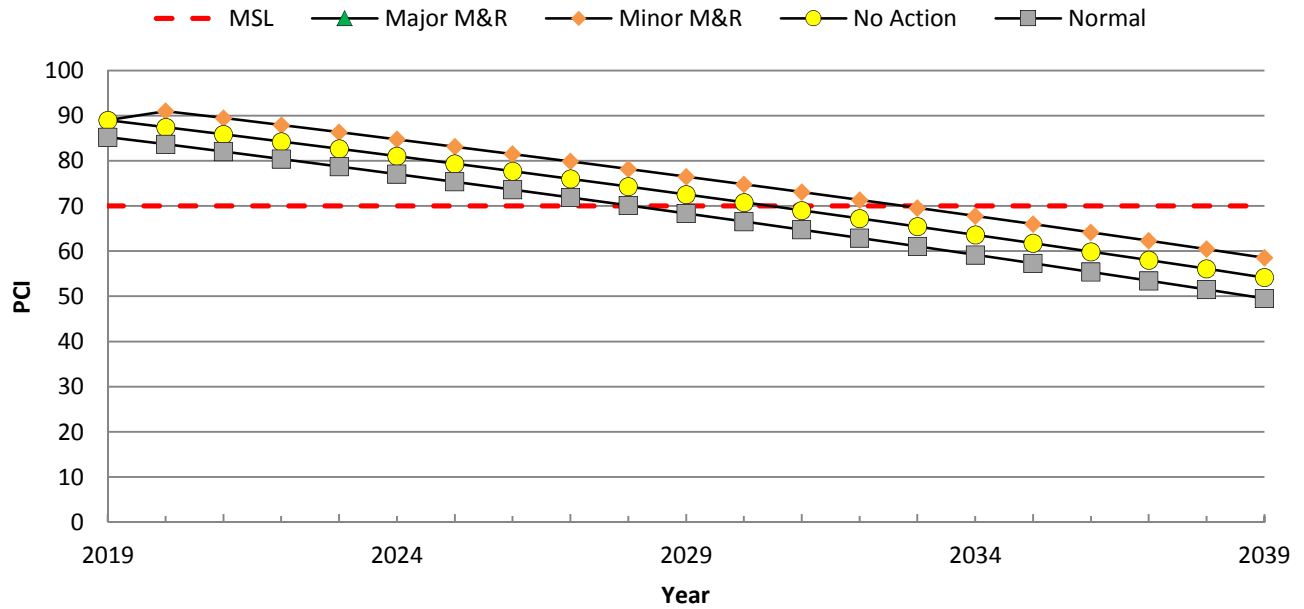

M&R	Action	Year / Quantity	Cost (\$)	Ending PCI
Major	-	-	-	-
Minor	All Minor	2020	1,386	91
1	Patching - AC Shallow	83 SqFt	1,386	-
2	-	-	-	-
3	-	-	-	-
4	-	-	-	-
5	-	-	-	-
6	-	-	-	-
7	-	-	-	-



ARA Pavement Analysis

Section:	81B::RTA::001
Description:	Runway Turnaround A
PaveType:	AC
Area:	12,450
Built:	1/15/2009
Age:	10yr

InspPCI:	92
InspPCI Rating:	Good
InspDate:	11/10/2018
PCI Family:	2019 MAINE AC RW-TW
NormalPCI:	85
MSL:	70

Work History	Year	Thickness (in)	Type
1	2009	0.0	complete reconstruction - ac
2	2009	3.0	surface course - ac (layer construct)
3	2009	6.0	base course - aggregate
4	-	-	-
5	-	-	-
6	-	-	-
7	-	-	-
8	-	-	-
9	-	-	-
10	-	-	-

Basic Cause of Distress:

Traffic/Load:	0%	Total Samples:	3
Age/Weather:	100%	Insp. Samples:	3
Other:	0%		

Extrapolated Distress:	Type	Quantity	Severity	Units
1	l & t crack	281	low	Ft
2	-	-	-	-
3	-	-	-	-
4	-	-	-	-
5	-	-	-	-
6	-	-	-	-
7	-	-	-	-
8	-	-	-	-
9	-	-	-	-
10	-	-	-	-
11	-	-	-	-
12	-	-	-	-
13	-	-	-	-
14	-	-	-	-
15	-	-	-	-
16	-	-	-	-
17	-	-	-	-
18	-	-	-	-
19	-	-	-	-
20	-	-	-	-

ARA Pavement Analysis

Section:

81B::RTA::001

Description:

Runway Turnaround A

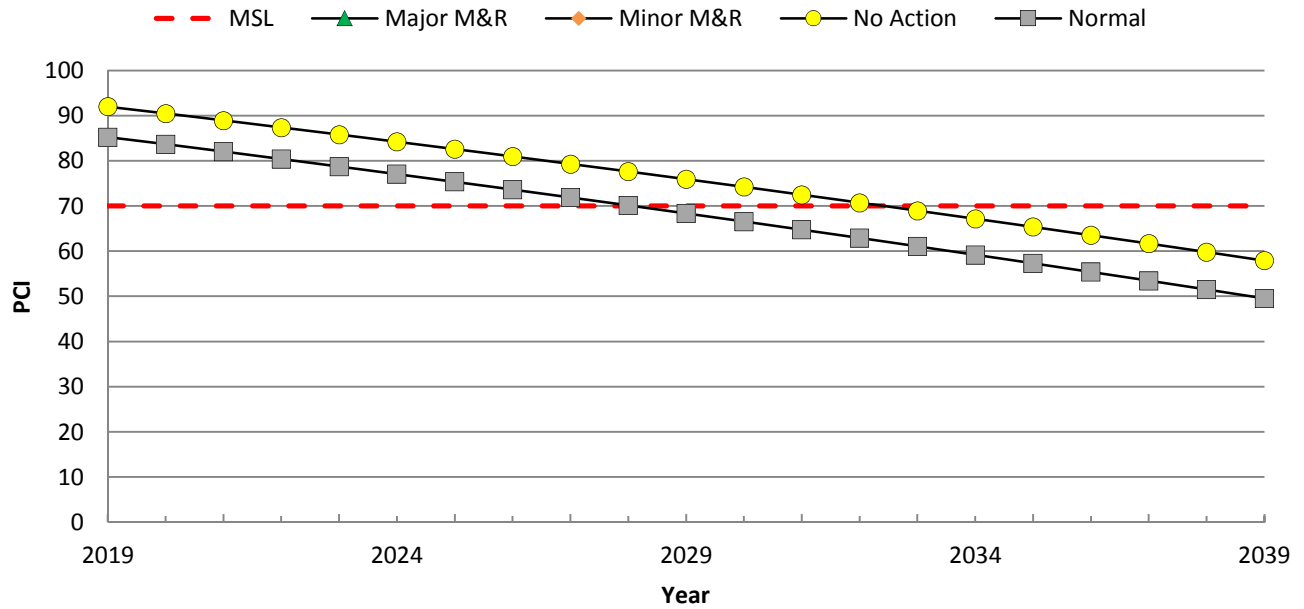

M&R	Action	Year / Quantity	Cost (\$)	Ending PCI
Major	-	-	-	-
Minor	-	-	-	-
1	-	-	-	-
2	-	-	-	-
3	-	-	-	-
4	-	-	-	-
5	-	-	-	-
6	-	-	-	-
7	-	-	-	-



ARA Pavement Analysis

Section:	81B::RTB::001
Description:	Runway Turnaround B
PaveType:	AC
Area:	12,650
Built:	1/15/2009
Age:	10yr

InspPCI:	96
InspPCI Rating:	Good
InspDate:	11/10/2018
PCI Family:	2019 MAINE AC RW-TW
NormalPCI:	85
MSL:	70

Work History	Year	Thickness (in)	Type
1	2009	0.0	complete reconstruction - ac
2	2009	3.0	surface course - ac (layer construct)
3	2009	6.0	base course - aggregate
4	-	-	-
5	-	-	-
6	-	-	-
7	-	-	-
8	-	-	-
9	-	-	-
10	-	-	-

Basic Cause of Distress:

Traffic/Load:	0%	Total Samples:	3
Age/Weather:	100%	Insp. Samples:	3
Other:	0%		

Extrapolated Distress:	Type	Quantity	Severity	Units
1	l & t crack	68	low	Ft
2	-	-	-	-
3	-	-	-	-
4	-	-	-	-
5	-	-	-	-
6	-	-	-	-
7	-	-	-	-
8	-	-	-	-
9	-	-	-	-
10	-	-	-	-
11	-	-	-	-
12	-	-	-	-
13	-	-	-	-
14	-	-	-	-
15	-	-	-	-
16	-	-	-	-
17	-	-	-	-
18	-	-	-	-
19	-	-	-	-
20	-	-	-	-

ARA Pavement Analysis

Section:

81B::RTB::001

Description:

Runway Turnaround B

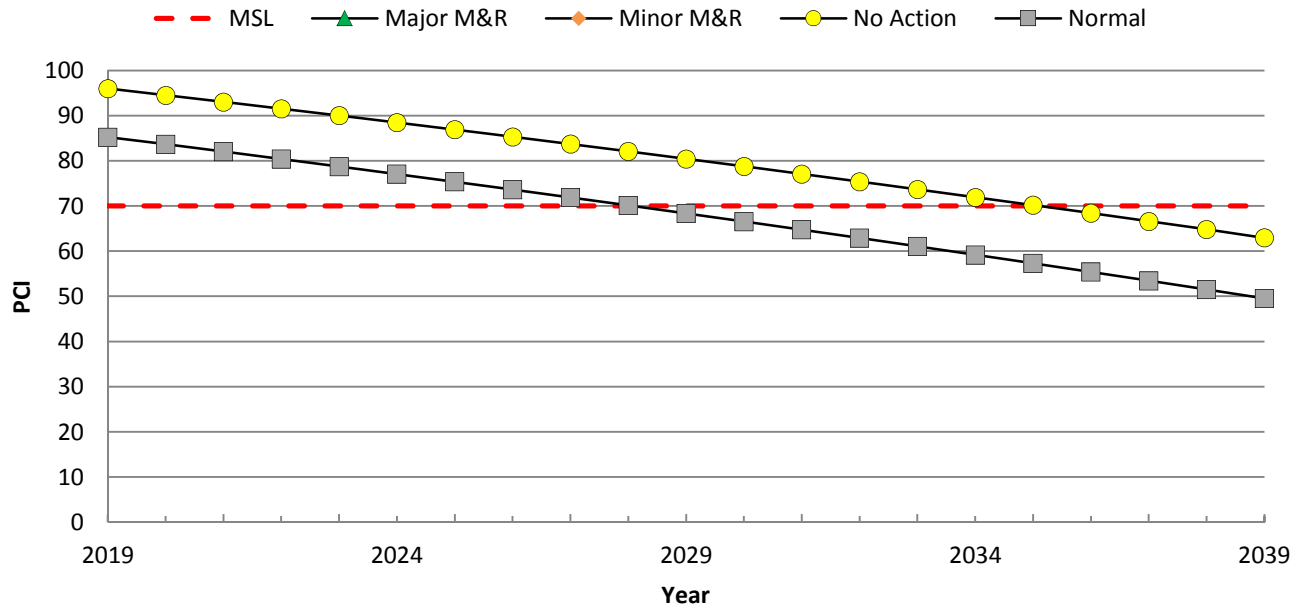

M&R	Action	Year / Quantity	Cost (\$)	Ending PCI
Major	-	-	-	-
Minor	-	-	-	-
1	-	-	-	-
2	-	-	-	-
3	-	-	-	-
4	-	-	-	-
5	-	-	-	-
6	-	-	-	-
7	-	-	-	-



ARA Pavement Analysis

Section:	81B::RY1533::001
Description:	Runway 15-33
PaveType:	AC
Area:	225,150
Built:	1/15/2009
Age:	10yr

InspPCI:	88
InspPCI Rating:	Good
InspDate:	11/10/2018
PCI Family:	2019 MAINE AC RW-TW
NormalPCI:	85
MSL:	70

Work History	Year	Thickness (in)	Type
1	2009	0.0	complete reconstruction - ac
2	2009	3.0	surface course - ac (layer construct)
3	2009	6.0	base course - aggregate
4	-	-	-
5	-	-	-
6	-	-	-
7	-	-	-
8	-	-	-
9	-	-	-
10	-	-	-

Basic Cause of Distress:

Traffic/Load:	0%	Total Samples:	60
Age/Weather:	100%	Insp. Samples:	7
Other:	0%		

Extrapolated Distress:	Type	Quantity	Severity	Units
1	l & t crack	9,272	low	Ft
2	-	-	-	-
3	-	-	-	-
4	-	-	-	-
5	-	-	-	-
6	-	-	-	-
7	-	-	-	-
8	-	-	-	-
9	-	-	-	-
10	-	-	-	-
11	-	-	-	-
12	-	-	-	-
13	-	-	-	-
14	-	-	-	-
15	-	-	-	-
16	-	-	-	-
17	-	-	-	-
18	-	-	-	-
19	-	-	-	-
20	-	-	-	-

ARA Pavement Analysis

Section:

81B::RY1533::001

Description:

Runway 15-33

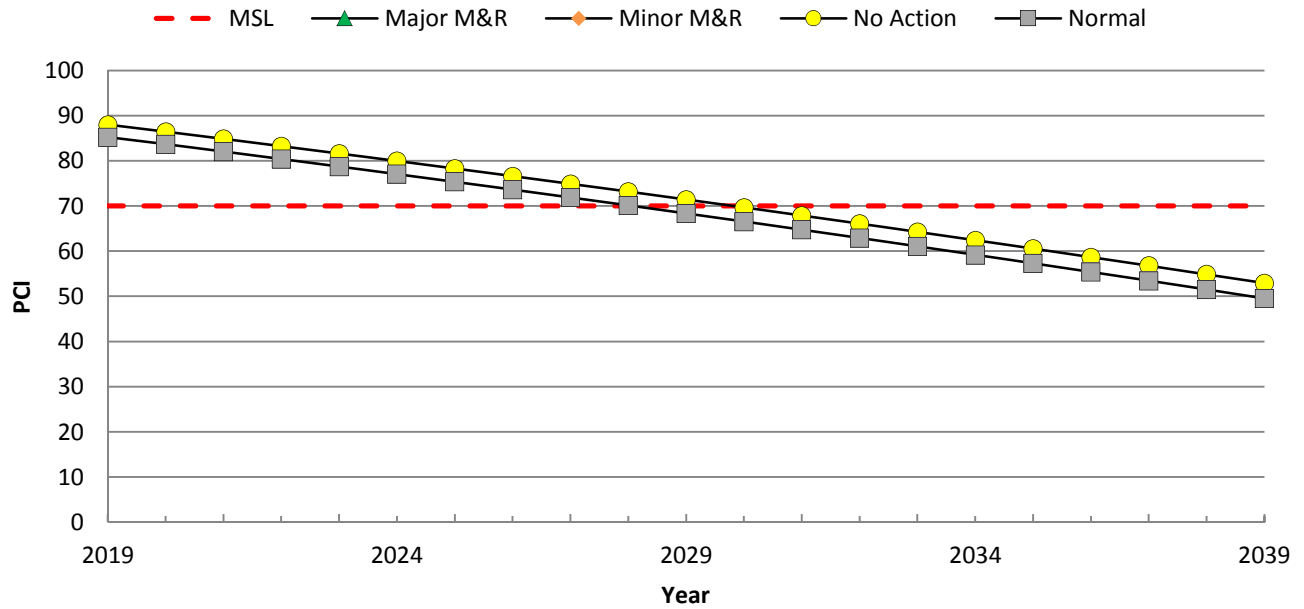

M&R	Action	Year / Quantity	Cost (\$)	Ending PCI
Major	-	-	-	-
Minor	-	-	-	-
1	-	-	-	-
2	-	-	-	-
3	-	-	-	-
4	-	-	-	-
5	-	-	-	-
6	-	-	-	-
7	-	-	-	-



This page intentionally left blank.

Appendix C: PCI Distress Report

This page intentionally left blank.

Re-Inspection Report

Network: 81B				Name: Oxford County Regional Airport		
Branch: APA	Name: Apron A	Use: APRON	Area: 222,800 SqFt			
Section: 001	of 1	From: a	To: b	Last Const.: 1/15/1973		
Surface: AC	Family: 2019 MAINE AC APRON- TLN	Zone:	Category:	Rank: P		
Area: 222,800 SqFt	Length: 1,125 Ft	Width: 200 Ft				
Slabs:	Slab Length: Ft	Slab Width: Ft	Joint Length: Ft			
Shoulder:	Street Type:	Grade: 0	Lanes: 0			
Last Insp. Date: 11/10/2018	Total Samples: 45	Surveyed: 7				
Conditions: PCI: 55						
Sample Number: 102	Type: R	Area: 3800.00 SqFt	PCI: 55			
48 L & T CR	L	175.00 Ft				
48 L & T CR	M	352.00 Ft				
48 L & T CR	H	12.00 Ft				
Sample Number: 201	Type: R	Area: 5000.00 SqFt	PCI: 54			
48 L & T CR	L	179.00 Ft				
48 L & T CR	M	351.00 Ft				
41 ALLIGATOR CR	M	30.00 SqFt				
48 L & T CR	H	20.00 Ft				
Sample Number: 205	Type: R	Area: 5000.00 SqFt	PCI: 61			
48 L & T CR	M	425.00 Ft				
48 L & T CR	L	269.00 Ft				
Sample Number: 209	Type: R	Area: 5000.00 SqFt	PCI: 42			
48 L & T CR	H	97.00 Ft				
41 ALLIGATOR CR	M	40.00 SqFt				
48 L & T CR	L	116.00 Ft				
48 L & T CR	M	410.00 Ft				
Sample Number: 300	Type: R	Area: 5000.00 SqFt	PCI: 65			
48 L & T CR	L	159.00 Ft				
48 L & T CR	M	327.00 Ft				
Sample Number: 306	Type: R	Area: 5000.00 SqFt	PCI: 64			
50 PATCHING	L	400.00 SqFt				
48 L & T CR	M	259.00 Ft				
48 L & T CR	L	286.00 Ft				
Sample Number: 409	Type: R	Area: 5000.00 SqFt	PCI: 45			
48 L & T CR	M	395.00 Ft				
48 L & T CR	L	272.00 Ft				
41 ALLIGATOR CR	M	40.00 SqFt				
48 L & T CR	H	64.00 Ft				

Network:	81B	Name:	Oxford County Regional Airport				
Branch:	CTA	Name:	Connecting Taxiway A	Use:	TAXIWAY	Area:	9,600 SqFt
Section:	001	of 1	From:	a	To:	b	Last Const.: 1/15/2009
Surface:	AC	Family:	2019 MAINE AC RW-TW	Zone:		Category:	Rank: P
Area:	9,600 SqFt	Length:	140 Ft	Width:	60 Ft		
Slabs:		Slab Length:	Ft	Slab Width:	Ft	Joint Length:	Ft
Shoulder:		Street Type:		Grade:	0	Lanes:	0
Last Insp. Date:	11/10/2018	Total Samples:	2	Surveyed:	2		
Conditions:	PCI: 83						
Sample Number:	100	Type:	R	Area:	6400.00 SqFt	PCI:	79
48	L & T CR		L	142.00	Ft		
48	L & T CR		H	30.00	Ft		
48	L & T CR		M	10.00	Ft		
Sample Number:	200	Type:	R	Area:	4000.00 SqFt	PCI:	89
48	L & T CR		L	65.00	Ft		
48	L & T CR		M	10.00	Ft		

Network:	81B	Name:	Oxford County Regional Airport				
Branch:	CTB	Name:	Connecting Taxiway B	Use:	TAXIWAY	Area:	9,200 SqFt
Section:	001	of 1	From:	a	To:	b	Last Const.: 1/15/2009
Surface:	AC	Family:	2019 MAINE AC RW-TW	Zone:		Category:	Rank: P
Area:	9,200 SqFt	Length:	140 Ft	Width:	60 Ft		
Slabs:		Slab Length:	Ft	Slab Width:	Ft	Joint Length:	Ft
Shoulder:		Street Type:		Grade:	0	Lanes:	0
Last Insp. Date:	11/10/2018	Total Samples:	3	Surveyed:	3		
Conditions:	PCI: 90						
Sample Number:	100	Type:	R	Area:	4000.00 SqFt	PCI:	90
56	SWELLING	L		56.00	SqFt		
48	L & T CR	L		62.00	Ft		
Sample Number:	200	Type:	R	Area:	4000.00 SqFt	PCI:	91
56	SWELLING	L		4.00	SqFt		
48	L & T CR	L		87.00	Ft		
Sample Number:	300	Type:	R	Area:	4000.00 SqFt	PCI:	88
56	SWELLING	L		4.00	SqFt		
48	L & T CR	L		134.00	Ft		

Network:	81B	Name:	Oxford County Regional Airport				
Branch:	CTC	Name:	Connecting Taxiway C	Use:	TAXIWAY	Area:	6,050 SqFt
Section:	001	of 1	From:	a	To:	b	Last Const.: 1/15/2009
Surface:	AC	Family:	2019 MAINE AC RW-TW	Zone:		Category:	Rank: P
Area:	6,050 SqFt	Length:	130 Ft	Width:	40 Ft		
Slabs:		Slab Length:	Ft	Slab Width:	Ft	Joint Length:	Ft
Shoulder:		Street Type:		Grade:	0	Lanes:	0
Last Insp. Date:	11/10/2018	Total Samples:	2	Surveyed:	2		
Conditions:	PCI: 89						
Sample Number:	100	Type:	R	Area:	3100.00 SqFt	PCI:	96
48	L & T CR		L		14.00 Ft		
Sample Number:	101	Type:	A	Area:	675.00 SqFt	PCI:	36
56	SWELLING		H		50.00 SqFt		
41	ALLIGATOR CR		L		50.00 SqFt		

Network:	81B	Name:	Oxford County Regional Airport				
Branch:	RTA	Name:	Runway Turnaround A	Use:	TAXIWAY	Area:	12,450 SqFt
Section:	001	of 1	From:	a	To:	b	Last Const.: 1/15/2009
Surface:	AC	Family:	2019 MAINE AC RW-TW	Zone:		Category:	Rank: P
Area:	12,450 SqFt	Length:	150 Ft	Width:	80 Ft		
Slabs:		Slab Length:	Ft	Slab Width:	Ft	Joint Length:	Ft
Shoulder:		Street Type:		Grade:	0	Lanes:	0
Last Insp. Date:	11/10/2018	Total Samples:	3	Surveyed:	3		
Conditions:	PCI: 92						
Sample Number:	100	Type:	R	Area:	4300.00 SqFt	PCI:	90
48	L & T CR		L		125.00 Ft		
Sample Number:	101	Type:	R	Area:	4000.00 SqFt	PCI:	91
48	L & T CR		L		105.00 Ft		
Sample Number:	102	Type:	R	Area:	3760.00 SqFt	PCI:	95
48	L & T CR		L		42.00 Ft		

Network:	81B	Name:	Oxford County Regional Airport				
Branch:	RTB	Name:	Runway Turnaround B	Use:	TAXIWAY	Area:	12,650 SqFt
Section:	001	of 1	From:	a	To:	b	Last Const.: 1/15/2009
Surface:	AC	Family:	2019 MAINE AC RW-TW	Zone:		Category:	Rank: P
Area:	12,650 SqFt	Length:	150 Ft	Width:	80 Ft		
Slabs:		Slab Length:	Ft	Slab Width:	Ft	Joint Length:	Ft
Shoulder:		Street Type:		Grade:	0	Lanes:	0
Last Insp. Date:	11/10/2018	Total Samples:	3	Surveyed:	3		
Conditions:	PCI: 96						
Sample Number:	100	Type:	R	Area:	4300.00 SqFt	PCI:	97
48	L & T CR		L	10.00	Ft		
Sample Number:	101	Type:	R	Area:	4000.00 SqFt	PCI:	96
48	L & T CR		L	21.00	Ft		
Sample Number:	102	Type:	R	Area:	3760.00 SqFt	PCI:	95
48	L & T CR		L	34.00	Ft		

Network:	81B	Name:	Oxford County Regional Airport				
Branch:	RY1533	Name:	Runway 15-33	Use:	RUNWAY	Area:	225,150 SqFt
Section:	001	of 1	From:	a	To:	b	Last Const.: 1/15/2009
Surface:	AC	Family:	2019 MAINE AC RW-TW	Zone:		Category:	Rank: P
Area:	225,150 SqFt	Length:	3,000 Ft	Width:	75 Ft		
Slabs:		Slab Length:	Ft	Slab Width:	Ft	Joint Length:	Ft
Shoulder:		Street Type:		Grade:	0	Lanes:	0
Last Insp. Date:	11/10/2018	Total Samples:	60	Surveyed:	7		
Conditions:	PCI: 88						
Sample Number:	101	Type:	R	Area:	3750.00 SqFt	PCI:	87
48	L & T CR		L	161.00	Ft		
Sample Number:	110	Type:	R	Area:	3750.00 SqFt	PCI:	82
48	L & T CR		L	252.00	Ft		
Sample Number:	119	Type:	R	Area:	3750.00 SqFt	PCI:	80
48	L & T CR		L	284.00	Ft		
Sample Number:	128	Type:	R	Area:	3750.00 SqFt	PCI:	89
48	L & T CR		L	129.00	Ft		
Sample Number:	137	Type:	R	Area:	3750.00 SqFt	PCI:	90
48	L & T CR		L	106.00	Ft		
Sample Number:	145	Type:	R	Area:	3750.00 SqFt	PCI:	93
48	L & T CR		L	75.00	Ft		
Sample Number:	155	Type:	R	Area:	3750.00 SqFt	PCI:	93
48	L & T CR		L	74.00	Ft		

This page intentionally left blank.

Appendix D: Distress Identification

This page intentionally left blank.

This appendix lists and describes distress types most commonly identified during the PCI inspections of Maine airports. Note that the pictures provided in this appendix are for illustration purposes and do not necessarily reflect the conditions or pavements at this airport. Descriptions and measurement inspection criteria are provided herein.

Flexible (Asphalt) Pavement Distress

Example of Longitudinal and Transverse Cracking (L&T cracking)



Longitudinal and transverse cracks are caused by pavement aging, by construction, and by subsurface movement. Aging occurs as pavement loses some of its components to the atmosphere and becomes more brittle. Consistent application of pavement sealcoats can help to prevent the occurrence of age related cracks. Cracks will also develop along poorly constructed paving lane joints. Ensuring that joints are made when both sides are still hot, and near the same temperature, is one of the best ways to mitigate this potential problem. Seasonal movement caused by changes in moisture content or temperature differences can also cause pavement cracks. Asphalt pavement placed over a PCC pavement or cement stabilized base course may evidence reflective cracking from the underlying material. Longitudinal and transverse cracks are not caused by wheel loads, although traffic may worsen their condition.

Low severity longitudinal and transverse cracks are less than $\frac{1}{4}$ inch wide, or if sealed with suitable filler material in satisfactory condition can be any width, less than 3 inches, if they are not spalled. Maintenance usually is not indicated for low-severity cracking. Moderately spalled cracks and cracks wider than $\frac{1}{4}$ inch which are not satisfactorily sealed are at medium severity. Medium-severity cracks should be sealed with a high-quality crack filling material. Severely spalled cracks and cracks wider than 3 inches are at high severity. High-severity L&T cracks normally require patching.

Example of Block Cracking



Block cracking is longitudinal and transverse cracking that has established a pattern of blocks ranging in size from 1ft x 1ft to 10ft x 10ft. This distress typically happens in older asphalt pavements and is an indication that the bituminous binder has lost most of its flexibility. The severity determination is basically determined by the crack width criteria defined for longitudinal and transverse cracking. Crack sealing typically is used to repair block cracking; however, the amount of required sealant can be extensive due to the high density of cracks.

Example of Alligator Cracking



Alligator (or fatigue) cracks are a series of interconnected load-related cracks caused by fatigue of the asphalt surface. Alligator cracking is a significant structural distress and develops only in places subject to traffic loads. These cracks typically initiate at the bottom of the asphalt layer (where tensile strains

are highest) and propagate upward - so once a fatigue crack is visible, significant damage has already occurred.

At low severity, alligator cracks are evidenced by a series of parallel hairline cracks (usually in a wheel path). Further traffic and deterioration leads to the interconnection of these cracks. Medium severity alligator cracking is a well-defined pattern of interconnected cracks, some spalling may be present. High severity alligator cracks have lost aggregate interlock between adjacent pieces, the cracks may be severely spalled with FOD potential, and most likely the pieces will move freely under traffic. Alligator cracking is a structural failure and cannot be repaired with sealant, the proper repair is full-depth patching.

Example of Raveling/Weathering



Raveling and weathering are the wearing away of the pavement surface. Raveling is the condition where the mid- to large size aggregates are becoming dislodged; weathering is when the fine aggregate wears away exposing the edges of the larger aggregate. These distresses are usually evident over large areas and may occur together (pictured above) or separately. Raveling and weathering may indicate that the asphalt binder has hardened significantly.

Raveling – At low severity, the number of missing coarse aggregates (> 3/8 inch) is between 5-20 missing/yd², medium severity (pictured below where the missing coarse aggregates have been dotted with yellow paint) is 21-40 missing/yd², and high severity is > 40 missing/yd².



Weathering – At low severity, the coarse aggregate is slightly exposed due to the wearing away of the fine aggregate. At medium severity, the coarse aggregate is exposed up to $\frac{1}{4}$ the width of the longest side. At high severity, the coarse is exposed greater than $\frac{1}{4}$ the width of the longest side.

Low severity



Medium severity



High severity



Example of Patching



Patched areas are defined when a portion of the original pavement is replaced with a material intended as a semi-permanent repair. A patch is documented as a defect because it is considered a break in the integrity of the pavement structure. Patches are constructed for a variety of reasons including utility repairs, correcting grade issues, and addressing a defect in the original pavement. The severity level of patches is determined by the amount of distress (i.e. cracking, depression, weathering/raveling, etc.) occurring within the limits of the patched area.

Example of Rutting



Ruts are localized, load related, areas of pavement having elevations lower than the surrounding sections. Rutting is due to base and subgrade consolidation, caused by excessive wheel loads or poor compaction. Ruts indicate structural failure, and can cause hydroplaning. At low severity, ruts have an

average depth of ¼ to ½ inches. At medium severity, ruts have an average depth of ½ to 1 inch. High severity, ruts have an average depth greater than 1 inch. Full-depth patching is the appropriate repair for ruts.

Rigid (Concrete) Pavement Distress

Example of Longitudinal, Transverse, and Diagonal Cracking



LTD cracking is most often a result of externally applied loads and/or constrained temperature deformations. External loads cause LTD cracking through flexure. Temperature changes on restrained slabs will result in stresses due to friction or curling. When any of these stresses exceed the strength of the slab, cracking will occur. LTD cracking is recorded at low, medium, or high severity, depending on the width of crack opening and degree of deterioration. At low severity, the crack is less than 1/8th inch wide with little spalling and no corrective action is indicated. At medium severity, LTD cracks can be up to 1 inch wide with moderate spalling, and should be repaired and sealed using procedures similar to joint sealing. At high severity, cracks exceed 1 inch in width and may be severely spalled. High-severity LTD cracking is evidence of serious load failure of the slab, and correction may require patching or slab replacement. If the distress occurs in several adjacent slabs at medium or high severity, major rehabilitation of that pavement area is indicated.

When a slab is divided by LTD cracks into four or more pieces, the slab is said to be "divided" or "shattered." Shattered slab is a separate distress category and is indicative of significant structural failure as the slab loses its ability to distribute loads to subgrade and further slab deterioration can be expected. Shattered slabs are rated in three severities, with slab replacement recommended for medium and high severities.

Example of Shrinkage Cracking



Shrinkage cracks are small, nonworking (no spalling along edge) cracks that are visible at the surface but do not penetrate through the full depth of concrete. Shrinkage cracks most commonly occur shortly after construction due to concrete shrinkage during the curing process. Shrinkage cracks are usually so small that they are not visible until staining or material loss at crack edges begins to take place. Shrinkage cracks do not represent a structural weakness, and no corrective action is prescribed.

Example of Joint and Corner Spalling



Spalls at slab joints and corners are caused by excessive internal stress in the pavement. Spalls occur when these stresses exceed the shear strength of the concrete. Spalling usually results from thermal expansion during warm or hot weather. As slabs expand, they push against one another at joints. If the joints are filled with incompressibles, such as sand, or if adjacent slabs offset slightly, stresses can become severe, causing spalls. Spalling can be reduced significantly by conscientious maintenance of joint sealant.

Spall repair requires patching. The extent and severity of spalling on a pavement surface suggests appropriate action. For example, at low severity, spalled concrete remains securely in place in the slab. A low-severity spall should be monitored closely for further deterioration and should be patched when

spalled particles become loose in place, or at the next scheduled patching activity in the section. Medium- and high-severity spalls should be repaired immediately to prevent the incidence of FOD. If the pavement can be restored to serviceable condition, spalls should be carefully patched for long-term service. If the pavement is beyond repair, temporary patching should be considered to control FOD.

Example of Durability Cracking



Durability cracking (D-cracking) is caused by environmental factors, the most common of which is freezing/thawing. It usually appears as a pattern of hairline cracks running parallel to a joint or crack, or in a corner, where water tends to collect. This type of cracking eventually leads to disintegration of the pavement, creating FOD potential. At low severity, D-cracking is evident, but no disintegration has occurred. As the distress advances to medium severity, the distress pattern is evident over a significant area of the slab, and some disintegration and FOD potential exists. High severity durability cracking is evidenced by extensive cracking with loose and missing pieces and significant FOD potential.

Example of Joint Seal Damage



Joint seal damage is recorded at three severities: low, medium, and high. When joint sealant is in perfect condition (no damage), it is not a distress. At low severity, at least 10 percent of the sealant is debonded but still in contact with the joint edges (i.e., joint sealant is in serviceable condition but should

be monitored for evidence of more serious failure). Medium-severity joint seal damage is recorded when at least 10 percent of the sealant has visible gaps smaller than 1/8th inch and is an indicator that replacement should be programmed as soon as is practicable. In the meantime, aggressive inspection and sustaining maintenance is recommended to minimize subsurface damage from moisture penetration. At high severity, visible gaps exceed 1/8th inch and the amount and degree of joint seal damage is such that repair is no longer feasible. The only appropriate corrective action is sealant replacement.

On serviceable pavement, deteriorated joint sealant should be repaired or replaced to preserve pavement and subgrade integrity and prolong service life. The issue is not so clear-cut with unserviceable pavement. Pavement that can be restored to serviceable condition by maintenance activities such as patching and joint seal repair, or by slab replacement, should be so maintained as long as the process is cost-effective. However, when age and condition preclude economical return to serviceable condition by such means, joint seal repair would no longer be cost-effective and should be suspended except for an interim maintenance program to control FOD potential.

Joint sealant can stop the evidence of pumping (water forced to surface through joints and cracks) but will not correct the cause (voids under pavement).

This page intentionally left blank.

Appendix E: Maintenance Policies

This page intentionally left blank.

Table E1. Localized maintenance policy for asphalt surfaces.

Distress type	Distress severity	Maintenance treatment
Alligator cracking	Low	Monitor
	Medium	Patching - AC Deep
	High	Patching - AC Deep
Bleeding	N/A	Monitor
Block cracking	Low	Monitor
	Medium	Crack Sealing - AC
	High	Crack Sealing - AC
Corrugation	Low	Monitor
	Medium	Patching - AC Shallow
	High	Patching - AC Shallow
Depression	Low	Monitor
	Medium	Patching - AC Shallow
	High	Patching - AC Shallow
Jet blast	N/A	Monitor
Joint reflection cracking	Low	Monitor
	Medium	Crack Sealing - AC
	High	Crack Sealing - AC
Longitudinal & transverse cracking (L&T cracking)	Low	Monitor
	Medium	Crack Sealing - AC
	High	Crack Sealing - AC
Oil spillage	N/A	Patching - AC Shallow
Patching	Low	Monitor
	Medium	Patching - AC Shallow
	High	Patching - AC Shallow
Polished aggregate	N/A	Monitor
Raveling	Low	Surface Treatment
	Medium	Surface Treatment
	High	Patching - AC Shallow
Rutting	Low	Monitor
	Medium	Patching - AC Deep
	High	Patching - AC Deep
Shoving	Low	Monitor
	Medium	Patching - AC Shallow
	High	Patching - AC Shallow
Slippage cracking	N/A	Patching - AC Shallow
Swelling	Low	Monitor
	Medium	Patching - AC Shallow
	High	Patching - AC Shallow
Weathering	Low	Monitor
	Medium	Surface Treatment
	High	Surface Treatment

Table E2. Localized maintenance policy for PCC surfaces.

Distress type	Distress severity	Maintenance treatment
Blow up	Low	Slab Replacement - PCC
	Medium	Slab Replacement - PCC
	High	Slab Replacement - PCC
Corner break	Low	Monitor
	Medium	Patching - PCC Full Depth
	High	Patching - PCC Full Depth
Linear cracking	Low	Monitor
	Medium	Crack Sealing - PCC
	High	Slab Replacement - PCC
Durability cracking	Low	Monitor
	Medium	Patching - PCC Full Depth
	High	Slab Replacement - PCC
Joint seal damage	Low	Monitor
	Medium	Joint Seal (Localized)
	High	Joint Seal (Localized)
Small patch	Low	Monitor
	Medium	Monitor
	High	Patching - PCC Full Depth
Large patch	Low	Monitor
	Medium	Monitor
	High	Patching - PCC Full Depth
Popouts	N/A	Monitor
Pumping	N/A	Monitor
Scaling	Low	Monitor
	Medium	Monitor
	High	Slab Replacement - PCC
Faulting	Low	Monitor
	Medium	Monitor
	High	Grinding (Localized)
Shattered slab	Low	Monitor
	Medium	Slab Replacement - PCC
	High	Slab Replacement - PCC
Shrinkage cracking	N/A	Monitor
Joint spall	Low	Monitor
	Medium	Patching - PCC Partial Depth
	High	Patching - PCC Partial Depth
Corner spall	Low	Monitor
	Medium	Patching - PCC Partial Depth
	High	Patching - PCC Partial Depth
ASR	Low	Monitor
	Medium	Slab Replacement - PCC
	High	Slab Replacement - PCC

Appendix F: Maintenance Repair Guidelines

This page intentionally left blank.

General Comments

Ongoing inspections are the cornerstone of a maintenance management program. Crack sealing prevents surface water from entering the pavement structure and helps prevent the introduction of incompressible material into the paving joints and cracks, reducing the chances for spalls and further pavement deterioration.

Preservation of a pavement system will require a combination of preventive, sustaining, and restorative maintenance repairs. Preventive maintenance is primarily an inspection program, sustaining maintenance is an ongoing maintenance function, whose purpose is to seal newly formed cracks in areas where the sealant is in otherwise satisfactory condition. Restorative repairs are major work items, often performed under contract that typically involve complete removal and replacement of existing sealant.

Maintenance Activities

Flexible (Asphalt) Pavement

Longitudinal and transverse (L&T) cracks at medium severity ($>1/4$ " wide) should be filled with a good quality crack filler material. High-severity cracks must normally be patched. Cracks rated at low severity may be narrow-unsealed cracks or sealed cracks up to 3 inches wide. The PCI procedure does not distinguish between narrow unfilled cracks and wider filled cracks. When 25 percent or more of total crack quantity is at medium or high severity, a restorative program becomes cost-effective. When medium- or high-severity cracking constitutes less than 25 percent of the total, sustaining maintenance is usually more cost-effective.

Medium- and high-severity existing patches should be replaced with new patches. Small areas (usually less than 100 square feet per patch) of alligator cracking and rutting at medium and high severity may also be repaired by patching. Larger patches should be considered if equipment can be made available to accomplish the work. Patching to repair up to 10 percent of the surface of a pavement section that is otherwise serviceable can result in significant cost savings as compared to rehabilitation of the entire section.

PCC (Concrete) Pavement

Joint seal damage at medium and high severity should be repaired. If medium- and high-severity damage is limited to less than about 25 percent of total joint length, sustaining maintenance is recommended. If medium and high-severity damage exceeds about 25 percent of the total joint length, joint sealant should be removed and replaced under a restorative repair project.

Longitudinal/transverse/diagonal (LTD) cracks at low and medium severity should be considered for sealing as part of the joint sealing project. High-severity LTD cracks require sealing, patching, or slab replacement, depending on the extent of deterioration.

Small patches are most often placed to repair medium- and high-severity spalls or to replace deteriorated older patches. Restorative small patches are typically partial depth repairs, usually to load transfer steel. Large patches and corner breaks at medium and high severity should be repaired by full-depth large patches.

High-severity LTD cracks and shattered slabs are candidates for patching and slab replacement. Low-severity shattered slabs can be left in place pending further deterioration.

Pavement Failure

Before maintenance and repairs are attempted, it helps to have an understanding of the way pavement performs and deteriorates.

Environmental/Age-Related Deterioration

Seasonal temperature changes cause expansion and contraction of the pavement materials, causing the pavement to move up to 1 foot per 1,000 feet. Much of this movement can be witnessed as the opening and closing of existing transverse cracks.

The pavement thickness and type of subgrade plays a large role in the formation and spacing interval of transverse cracks. If the subgrade material is smooth or rounded, the pavement surface will move relatively freely, the transverse cracks will usually be spaced far apart (>60 feet). If the subgrade material is rough or angular the pavement surface will not move freely and transverse cracks will be spaced more closely (<40 feet). The distance between transverse cracks will also depend on the pavement thickness, as a thicker pavement can resist cracking for longer lengths, but around 50 feet is typical for general aviation airport pavements.

Age related distress deals with the pavement oxidation or loss of volatile components to the atmosphere. An oxidized pavement becomes more brittle with time. Surface treatments and seal coats are designed, in part, to provide a protective barrier and prevent this type of oxidation.

Materials Related Deterioration

Subsurface water can have the greatest impact on pavement deterioration. A wet subgrade greatly reduces the ability of a pavement to support wheel loads, and the results often show up as rutting and cracking. The fine materials in a wet base can be pumped up through the cracks and eventually result in a loss of subgrade support. This loss of support can be evidenced as corner breaks and faulting. Moisture inside a pavement system expands when it freezes; creating stresses that push and tear at the pavement. The following thaw cycles will leave voids in the pavement structure that enable further rutting and breaking. Repeated freeze/thaw cycles will eventually cause pavement to disintegrate. One of the best ways to assure pavement longevity is to provide drainage and keep the subgrade dry.

Aggregate is the biggest component of any pavement structure, and it is the contact between the aggregate particles that actually transfers the load and provides the strength. Aggregate durability and shape are major factors affecting pavement performance. Durability is the ability of the aggregate to perform satisfactorily over time and resist the detrimental effect of nature. Sharp, well-angled aggregate that interlock, compact densely, and resists movement are the most desirable.

Air Voids

Well-distributed interconnected air voids allow escape paths for freezing water and generally reduce susceptibility to freeze/thaw damage. In PCC pavements, closely spaced interconnected air voids provide the greatest degree of protection.

Asphalt pavements, on the other hand, only tolerate air voids as necessary. Air voids allow for expansion of the asphalt binder, but also allow water penetration into the pavement. Interconnected air voids are undesirable here because the voids allow air to penetrate the asphalt layers and oxidize the binder. As air voids increase, durability and flexibility decrease, but stability and skid resistance increase. Asphalt pavements should be designed and compacted so that air voids are not interconnected. The air voids should allow only for the expansion of the asphalt and aggregate without bleeding, and air voids should be kept low enough to prevent water and air from penetrating the asphalt layers.

Binders

Regardless of whether the pavement is asphalt or concrete, the binder material is mixed with the aggregate to coat all particles with a thin film. An asphalt coating allows the pavement to be flexible and still resist large movements. Durability of the asphalt pavement is increased by a thicker film because it is more resistant to age hardening; however, too thick of a film and the asphalt acts like a lubricant, promoting ruts, shoving, and bleeding. Specifications control aggregate and binder mix quantities, but each mix should be customized for materials available locally.

With a concrete pavement, the aggregate supports the load, but the cement binder interlocks with the aggregate to inhibit all movement. Hydration is the term for the chemical reaction of portland cement with water, and in the hydration process, dry cement particles react with water, to form gels, and then crystals, that grow and bond with the aggregate to form a rigid interlocking structure. Hydration can continue for years, but much of the ultimate strength will be reached within 28 days. Hydration is a sensitive chemical process, and typically, any admixtures used to accelerate the hydration process will reduce durability, and their use should be considered carefully or avoided.

Stress Distribution/Load Related Deterioration

PCC (rigid) and asphalt (flexible) pavements differ in the way loads are distributed. A concrete slab resists bending and transfers loads evenly, an asphalt pavement is designed to bend, and gradually spreads loads over wider areas. Rutting is a subgrade failure caused by a compressive yielding of the subgrade.

Load-related cracks can start at the top or bottom of a pavement section. In asphalt sections, load-related (fatigue) cracks start at the bottom. If a load-related crack reaches the surface, it usually indicates significant structural deficiency. In PCC pavement, corner breaks are caused by top tension, and the crack propagates downward. Mid-slab LTD cracks are examples of bottom tension.

Spalls can be caused by either wheel loads or environmental factors, anytime there is movement between adjacent slabs. If a small rock is allowed into a joint, a differential movement between adjacent slabs can cause a spall. Spalling can be minimized by keeping joint and crack sealant intact.

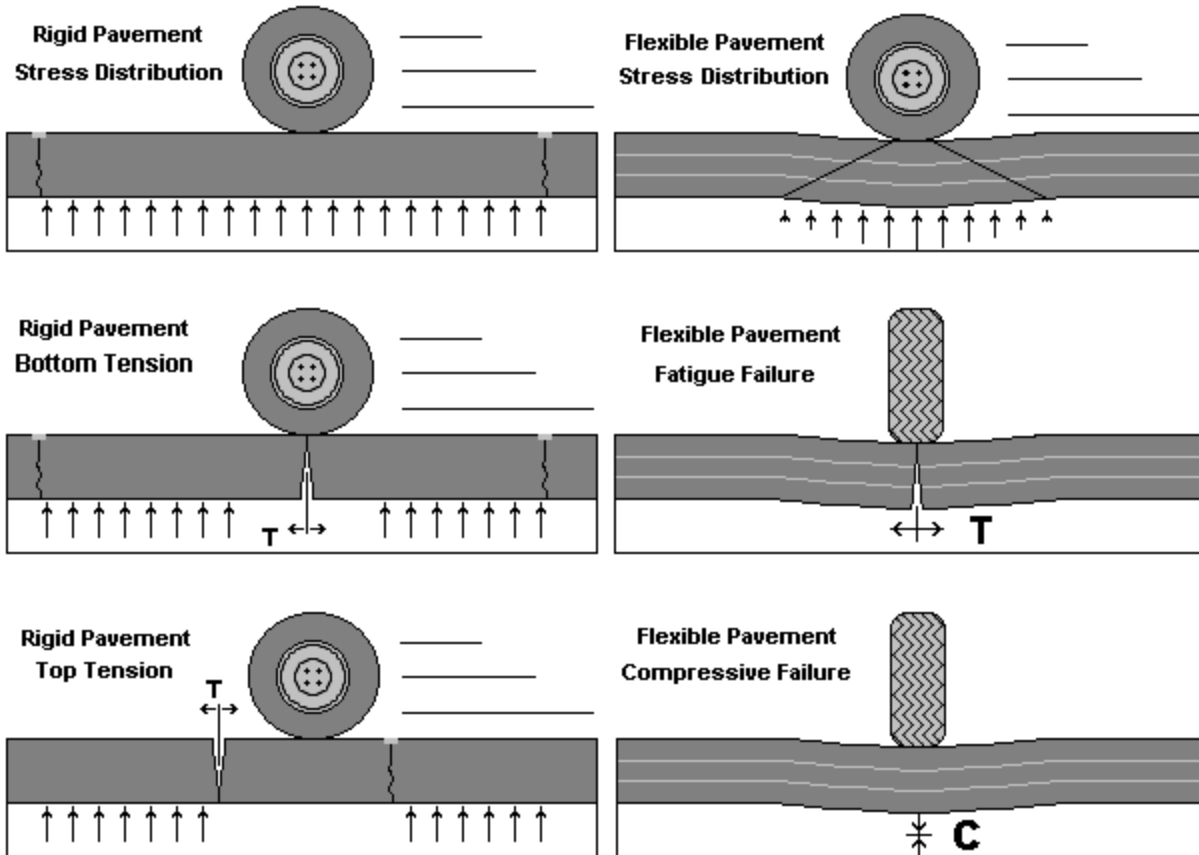

Figure 10. Pavement failure.

Points to Remember

Pavement wears out.

The longer a pavement remains in service, the greater the effort needed to keep it in service. A good maintenance and repair program will increase service life significantly, but cannot be expected to extend service life indefinitely.

Pavement moves.

Pavement moves in response to temperature changes. Transverse cracks can vary from nearly closed in the summer to open an inch or more in winter. This movement cannot be prevented. It must be understood and provided for during design and construction. The changing crack widths will dictate the reservoir size required for sealant. Measure cracks at their widest and narrowest states, then prepare adequate ($\frac{1}{2}$ - $1\frac{1}{2}$ inch) sealant reservoirs for crack sealing projects.

Longitudinal joints and cracks are important.

The most important reason for sealing cracks is to deny surface water access to the pavement and subgrade. Most water drains from centerline to shoulders. Longitudinal cracks, which run parallel to the centerline provide the greatest potential to divert water into the pavement structure, and must be sealed.

Sealing is not always the best answer.

The FAA maximum allowable open trench width on aircraft movement areas is three-inches; therefore, any crack wider than three-inches should be patched. A severe spall or a crack that has settled below the pavement elevation indicates a failure. If the pavement has disintegrated to the point that aggregate interlock is lost, sealant alone will not be sufficient, and patching should be considered.

Maintenance and repairs must be done correctly.

To achieve optimum results from repairs, proper preparation, use of quality materials, and proper application are essential. Any shortcuts will reduce the quality and effectiveness of the repairs. A rule of thumb is that proper maintenance will last twice as long as an unprepared area. Good maintenance takes time and deserves high-quality materials.

Schedule maintenance and repair activities carefully.

Any pavement defect can be corrected. Concentrate on repairs that are cost-effective, operationally important, and that extend service life. Some surface blemishes can be ignored safely, and many structural problems are beyond economical correction. When future rehabilitation is imminent, maintenance activities should be limited to only those that ensure continued safety and minimize foreign object damage (FOD) potential.

Equipment

Many excellent pavement repair and sealing products are available. Specialized tools and equipment help ensure quality repairs. This section reviews equipment compatible with airport needs.

Air Compressor

Used to remove sand and debris from prepared cracks and joints, the compressor should have a sustained capacity of 120 cubic feet per minute with a nozzle velocity of 100 psi. Trailer-mounted compressors typically have capacities in this range.

Concrete Saw

A saw capable of making a minimum 3-inch deep cut is required. The saw should be capable of making cuts in asphalt or concrete. Gasoline-powered 5-25 hp wheel mounted saws typically are preferred for this type of work, but electric and pneumatic tools are also available.

Heating Kettle

Applying sealant is the most time-consuming operation, and a sealing machine with heating and pressure application capabilities is a critical item in a sealing program. The capacity of the sealing equipment dictates the rate at which a crew progresses. For large sealing projects, a minimum 100 gallons/per hour sustained capacity is recommended. The unit should be a double boiler type, with mechanical agitators or continuous recirculation.

Router

A concrete saw can be used to prepare joints, but for random cracking, a mechanical router with a vertical impact mechanism is preferred. When cracks are being routed, this activity will dictate speed of the crew. Crack routers in the 25hp range are commonly used and are available from a variety of manufacturers.

Sand Cleaner

A sand blaster helps to clean loose particles and dust from prepared cracks. The unit must have sufficient force to expose fresh, vital pavement to bond with sealant and patching materials.

Vibratory Roller or Plate Compactor

Required to properly compact plant mixed and packaged patching materials. Small rollers are best for pothole type applications, plate compactors are best for large areas.

Other Equipment

Other general use equipment that can be helpful in a maintenance program includes bucket loaders, dump trucks, water tanks, and a power sweeper unit.

Materials

Pavement repair materials are constantly being introduced and improved. This section provides information on products compatible with airport needs.

Joint and Crack Sealer

Hot poured, pressure injected, polymeric rubberized asphalt sealant meeting ASTM D3405 specifications is suitable for most joint and crack sealing requirements. This product is relatively inexpensive, durable, and suitable for both PCC and asphalt pavements. Other, more expensive, hot applied sealants that promise longer life are being developed for specialty applications, and twin component cold applied sealants, similar to URASEAL 200, have also been used with success. Contact your local distributor.

Flexible Pavement Patch

Long-term patches should be made with a high-quality plant mixed hot asphalt having a ¾-inch maximum aggregate size and meeting FAA P401, or highest quality highway specifications. High-performance plant mixed cold patching products that can be stockpiled on-site have been developed. Low-quality packaged materials available from local hardware type stores should be avoided and only be used for temporary patches that maintain safety and service.

PCC Pavement Patch

Permanent patches in PCC pavement should be made with a minimum 6-bag mix of hi-early air-entrained cement with 1-inch maximum size aggregate. Concrete should have zero slump and a coarse texture. As with asphalt patches, low-quality packaged materials should only be used as temporary patches to maintain safety and service until a more permanent repair can be made.

Techniques

Crack Sealing

- Cracks over $\frac{1}{4}$ inches wide should be sealed. Cracks wider than 3 inches should be patched.
- Sealant depth above the backer rope should be equal to the width of the reservoir, or as recommended by the manufacturer.
- Routed cracks should be sand blasted, to prepare the vertical edges for bonding with the sealant. Clean cracks with compressed air prior to sealing.
- Backing material should always be placed into the cracks. Commercial products are available, and several sizes of rope should always be available to accommodate various crack sizes.
- Apply sealant after placing the backer rope. Follow the manufacturer's instructions. Sealant should be applied to within $\frac{1}{4}$ inch of the pavement surface.
- The final activity is to clean the surrounding pavement areas. A vacuum sweeper works well for this. Allow the sealant time to set, before using a broom.

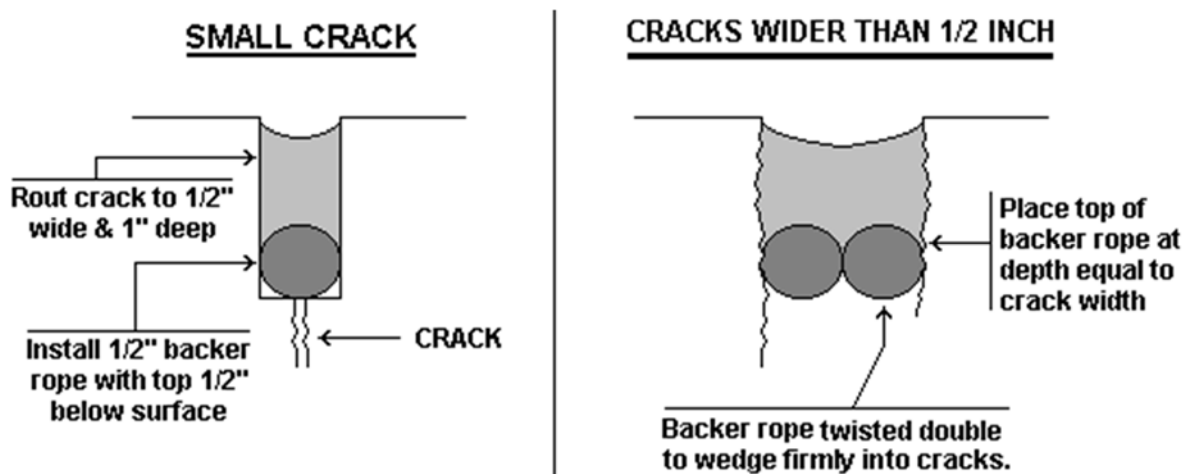

Figure 11. Crack sealing.

Note:

This crack sealing technique is meticulous in its design and procedure. It has a proven record of performance. Using backer rope forces the sealant into a predictable shape—narrow in the center and wide on the sides. This sealant profile allows the sealant to firmly bond with the vertical edges, yet stretch easily with pavement movement. In an effort to minimize labor requirements and reduce crack-sealing costs, an alternative procedure, the overband technique, is presented on the following page. This procedure can produce good results for up to 5 years.

Always remember that, within reasonable limits, thinner sealant material will stretch more easily with the pavement movement, and stay bonded longer.

Asphalt Pavement Crack Repair

Cracks wider than 3 inches should be patched. Cracks with secondary cracking and vertical movement should also be patched. Failed existing patches should be replaced. Crack repair can also repair small areas of alligator cracking and rutting. Crack repair differs from sealant in that it restores load-bearing capacity. Therefore, it must be constructed carefully to distribute stresses evenly and perform as an integral piece of the surrounding pavement. The crack repair must be wide enough to ensure that it bonds to fresh, vital pavement on all sides, and deep enough to reach fresh underlying layers, but never less than 3 inches.

- Examine the distressed area and mark the crack repair outline. This examination may require a pick or chisel to test the pavement integrity in and around the distressed area.
- The crack repair area should be cut out with a vertical saw cut not less than 3 inches deep.
- The enclosed pavement should then be removed, leaving the vertical sawed edges undamaged and providing a relatively even, flat floor at the appropriate depth.
- The sides and bottom should be sand cleaned and blown out with compressed air
- The sides and bottom should then be painted with a rapid curing asphalt tack coat. The tack coat may be sprayed on or applied with a brush or rag. Care should be taken to achieve complete coverage without allowing excess material to “pool” on the bottom.
- Allow tack coat to cure (about 2 to 4 hours) until it reaches a gummy consistency, which readily retains the impression of a fingerprint.
- Place hot mixed asphalt concrete evenly and mound slightly above surrounding pavement. Allow approximately ¼ inch of compaction for each inch of patch depth.
- Compact in place with vibratory roller or plate compactor. Asphalt concrete should not be compacted in layers greater than 6 inches. If crack repair depth is greater than 6 inches, asphalt concrete should be placed and compacted in successive layers.
- In deep, narrow cracks such as at joint reflective cracks, a sand asphalt mix may be required in lower layers to allow movement and prevent bridging the adjacent slabs.
- Considerable judgment is required in placing the asphalt concrete to achieve a fully compacted crack repair without creating a bump or depression. The ¼ inch per inch factor is a rule of thumb. Actual compression will vary with the mix. Experimentation and experience are required to achieve optimum results.

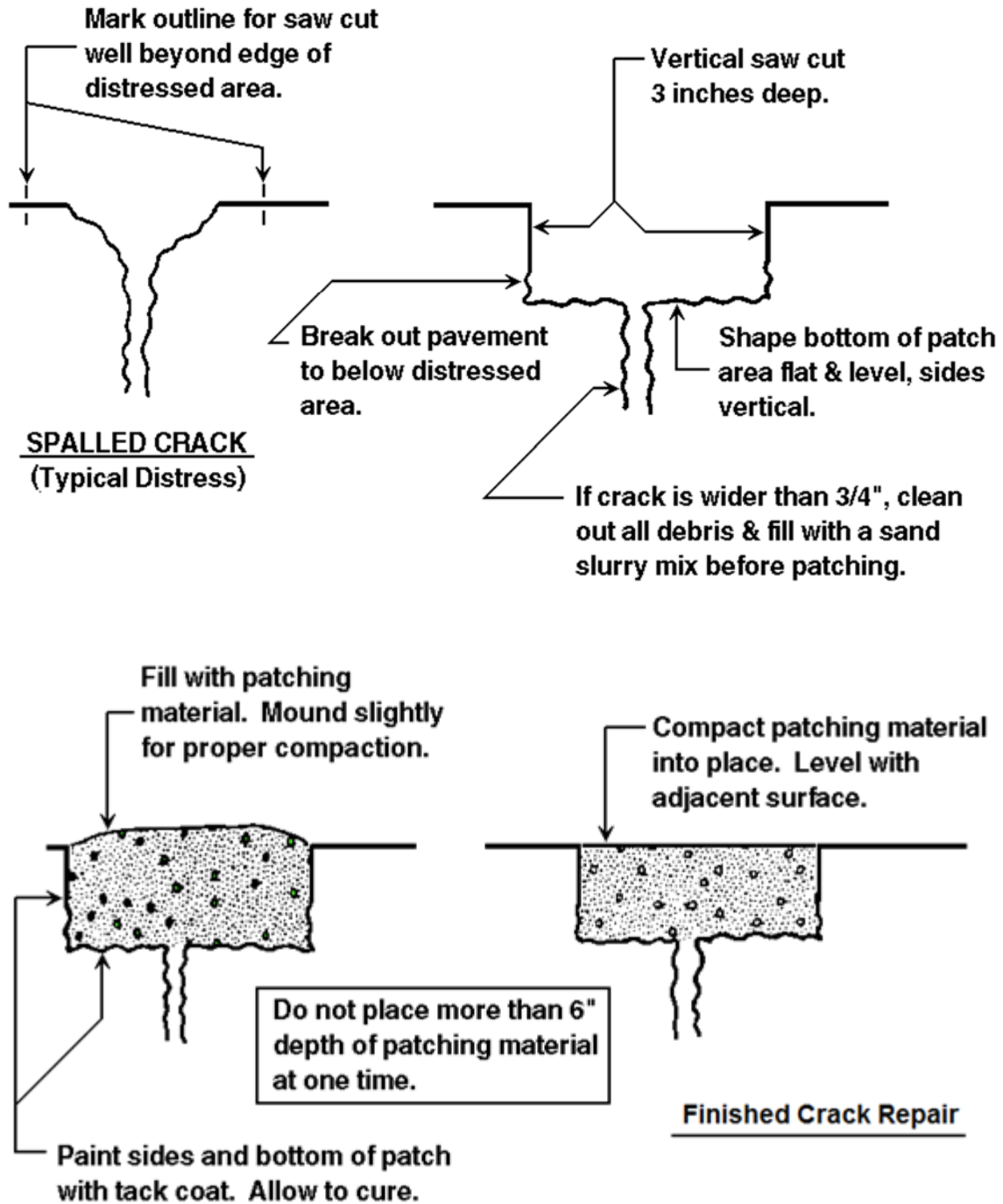

Figure 12. AC crack repair.

Patching (Asphalt Pavement)

Cracks wider than 3 inches should be patched. Cracks with secondary cracking and vertical movement should also be patched. Failed existing patches should be replaced. Patching can also repair small areas of alligator cracking and rutting. A patch differs from sealant in that it restores load-bearing capacity. Therefore, it must be constructed carefully to distribute stresses evenly and perform as an integral piece of the surrounding pavement. The patch must be wide enough to ensure that it bonds to fresh, vital pavement on all sides, and deep enough to reach fresh underlying layers, but never less than 3 inches.

- Examine the distressed area and mark the patch outline. This examination may require a pick or chisel to test the pavement integrity in and around the distressed area.
- The patch area should be cut out with a vertical saw cut not less than 3 inches deep.
- The enclosed pavement should then be removed, leaving the vertical sawed edges undamaged and providing a relatively even, flat floor at the appropriate depth.
- The sides and bottom should be sand cleaned and blown out with compressed air
- The sides and bottom should then be painted with a rapid curing asphalt tack coat. The tack coat may be sprayed on or applied with a brush or rag. Care should be taken to achieve complete coverage without allowing excess material to “pool” on the bottom.
- Allow tack coat to cure (about 2 to 4 hours) until it reaches a gummy consistency, which readily retains the impression of a fingerprint.
- Place hot mixed asphalt concrete evenly and mound slightly above surrounding pavement. Allow approximately ¼ inch of compaction for each inch of patch depth.
- Compact in place with vibratory roller or plate compactor. Asphalt concrete should not be compacted in layers greater than 6 inches. If patch depth is greater than 6 inches, asphalt concrete should be placed and compacted in successive layers.
- In deep, narrow patches such as at joint reflective cracks, a sand asphalt mix may be required in lower layers to allow movement and prevent bridging the adjacent slabs.
- Considerable judgment is required in placing the asphalt concrete to achieve a fully compacted patch without creating a bump or depression. The ¼ inch per inch factor is a rule of thumb. Actual compression will vary with the mix. Experimentation and experience are required to achieve optimum results.

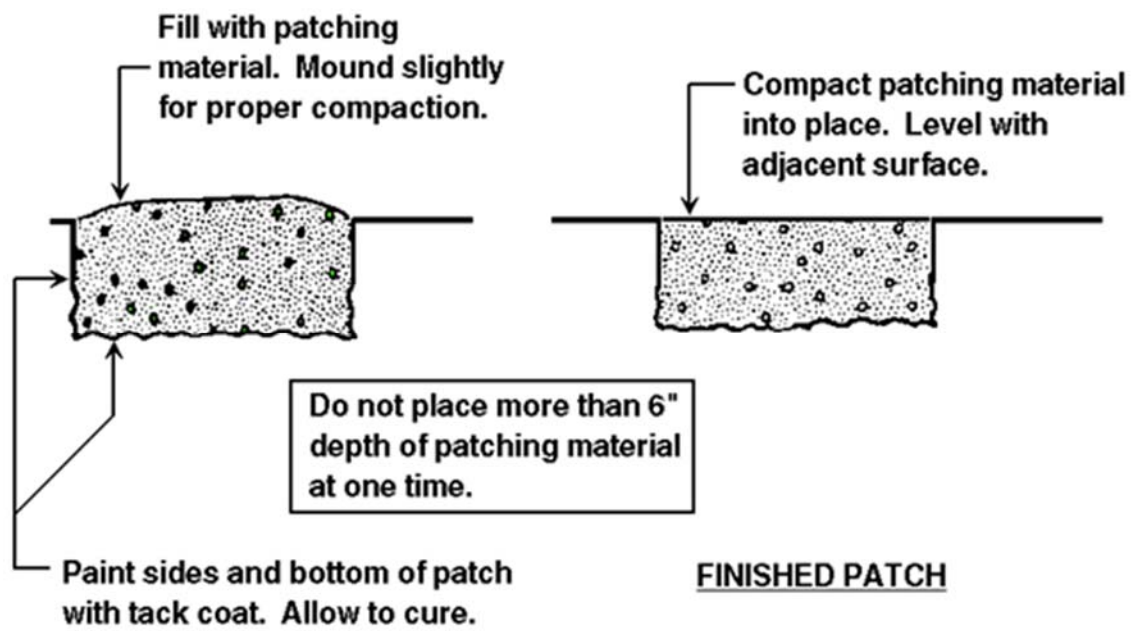
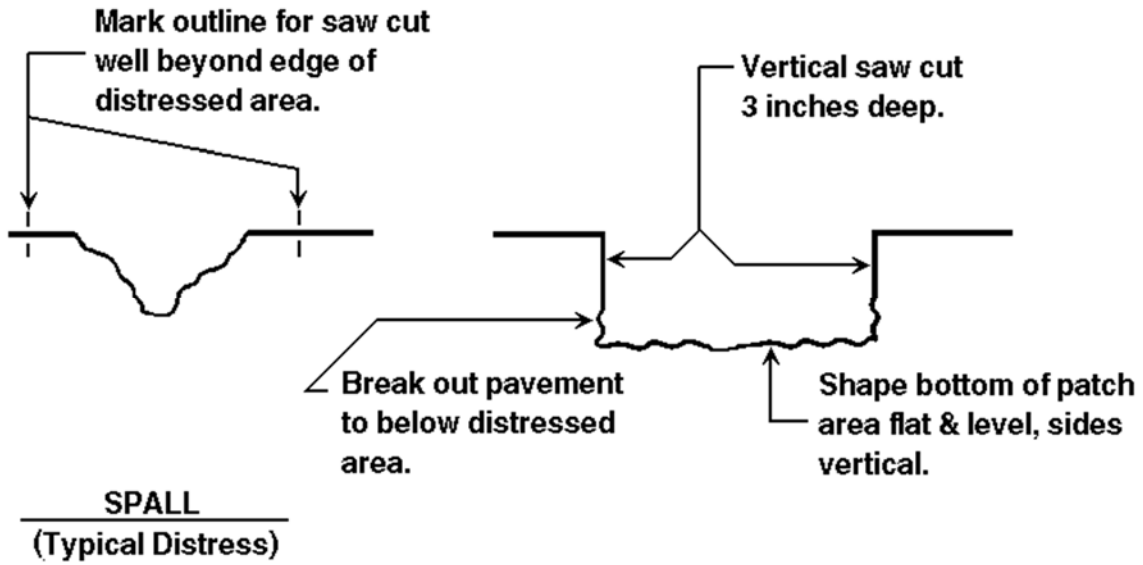

Figure 13. AC patch.

Table 13. Maintenance and “drive by” inspection log.

Inspection Date	Inspector	Pavement location (branch/section)	Change in condition (new distress type, increased quantity or severity)	Maintenance performed since last inspection